



reddot design award

## Allround Easy. Allround Secure.

Elegant, ultra-compact and weatherproof 5MP dome camera. Its 360° allround view allows monitoring and recording an entire room, while the panorama image and image analysis tools of the Q25M Hemispheric provide an unparalleled range of application scenarios.



5 MP  
Sensor

MxLEO



360°

vPTZ



MxBUS

USB

+50°  
-30°

IP65



Innovations – Made in Germany

The German company MOBOTIX AG is known as the leading pioneer in network camera technology and its decentralized concept has made high-resolution video systems cost efficient.

MOBOTIX AG • D-67722 Langmeil • Tel: +49-6302-9816-103 • Fax: +49-6302-9816-190 • sales@mobotix.com

## THE MOBOTIX INFORMATION CHANNELS



### Support on the MOBOTIX Website

[www.mobotix.com/other/Support](http://www.mobotix.com/other/Support)



### The MOBOTIX Video Tutorials

[www.mobotix.com/other/Support/Tutorials](http://www.mobotix.com/other/Support/Tutorials)



### Seminars on MOBOTIX Campus

[www.mobotix.com/other/Partners/Seminars](http://www.mobotix.com/other/Partners/Seminars)



### The MOBOTIX YouTube Channel

[www.youtube.com/MOBOTIXAG](http://www.youtube.com/MOBOTIXAG)

## MOBOTIX Seminars

MOBOTIX offers inexpensive seminars that include workshops and practical exercises. For more information, visit [www.mobotix.com](http://www.mobotix.com) > **Seminars**.

## Copyright Information

**All rights reserved.** *MOBOTIX*, the MX logo, *MxControlCenter*, *MxEasy* and *MxPEG* are trademarks of MOBOTIX AG registered in the European Union, the U.S.A., and other countries. *Microsoft*, *Windows* and *Windows Server* are registered trademarks of Microsoft Corporation. *Apple*, the Apple logo, *Macintosh*, *OS X*, *iOS*, *Bonjour*, the Bonjour logo, the Bonjour icon, *iPod* and *iTunes* are trademarks of Apple Inc. registered in the U.S.A. and other countries. *iPhone*, *iPad*, *iPad mini* and *iPod touch* are Apple Inc. trademarks. *Linux* is a trademark of Linus Torvalds. All other marks and names mentioned herein are trademarks or registered trademarks of the respective owners.

Copyright © 1999-2014 MOBOTIX AG, Langmeil, Germany. Information subject to change without notice!

Download the latest version of this and other manuals as PDF files from [www.mobotix.com](http://www.mobotix.com) > **Support** > **Manuals**.

CONTENTS

|            |   |           |
|------------|---|-----------|
| <b>1</b>   | <b>Product Overview</b>                           | <b>10</b> |
| <b>1.1</b> | <b>Q25M Hemispheric</b>                           | <b>10</b> |
| 1.1.1      | General Product Characteristics                   | 10        |
| 1.1.2      | Hemispheric Technology                            | 21        |
| 1.1.3      | Advantages and New Features                       | 24        |
| 1.1.4      | Decentralized Video System                        | 26        |
| 1.1.5      | Green IP Video                                    | 28        |
| <b>1.2</b> | <b>Technical Specifications</b>                   | <b>30</b> |
| 1.2.1      | Lens Options                                      | 30        |
| 1.2.2      | Camera Variants – Lenses, Hardware, Image Formats | 32        |
| 1.2.3      | Camera Variants – Software Features               | 33        |
| 1.2.4      | Technical Data                                    | 34        |
| <b>1.3</b> | <b>Delivered Parts and Dimensions</b>             | <b>36</b> |
| 1.3.1      | Q25M Camera                                       | 36        |
| 1.3.2      | Mounting Kits and Mounts                          | 39        |
| <b>1.4</b> | <b>Available Accessories</b>                      | <b>48</b> |
| 1.4.1      | On-Wall Set                                       | 48        |
| 1.4.2      | 10° On-Wall Set                                   | 48        |
| 1.4.3      | Vandalism Set                                     | 48        |
| 1.4.4      | In-Ceiling Set                                    | 49        |
| 1.4.5      | Outdoor Wall Mount                                | 49        |
| 1.4.6      | Corner and Pole Mount                             | 49        |
| 1.4.7      | Stand/Wall Mount for Camera Tests                 | 49        |
| 1.4.8      | MiniUSB Cable to MiniUSB (Angled/Straight)        | 50        |
| 1.4.9      | MiniUSB Cable to MiniUSB (Angled/Angled)          | 50        |
| 1.4.10     | MiniUSB Cable to USB-A Socket                     | 50        |
| 1.4.11     | Ethernet Patch Cable for Bayonet Catch            | 50        |
| 1.4.12     | NPA-PoE-Set                                       | 51        |
| 1.4.13     | MX-Overvoltage-Protection-Box                     | 51        |
| 1.4.14     | MX-NPA-Box  | 51        |
| 1.4.15     | MX-GPS-Box  | 52        |
| 1.4.16     | MX-232-IO-Box                                     | 52        |
| 1.4.17     | ExtIO Expansion Module                            | 52        |
| 1.4.18     | Mx2wire+ Media Converter                          | 53        |
| 1.4.19     | Other Accessories                                 | 53        |
| <b>1.5</b> | <b>MOBOTIX Software</b>                           | <b>54</b> |
| 1.5.1      | Integrated Camera Software (Firmware)             | 54        |
| 1.5.2      | MxControlCenter                                   | 55        |
| 1.5.3      | MxEasy  | 56        |
| 1.5.4      | MOBOTIX App                                       | 57        |

|            |   |            |
|------------|---|------------|
| <b>2</b>   | <b>Installation</b>   | <b>58</b>  |
| <b>2.1</b> | <b>Preparing the Installation</b>                               | <b>58</b>  |
| 2.1.1      | Wall-Mounted  | 59         |
| 2.1.2      | Ceiling-Mounted   | 62         |
| 2.1.3      | Mounting Options  | 65         |
| 2.1.4      | Network Connection And Power Supply, UPS                        | 68         |
| 2.1.5      | Preparing the Camera Connections, MX-Overvoltage-Protection-Box | 69         |
| 2.1.6      | Wiring, Fire Prevention, Lightning and Surge Protection         | 70         |
| <b>2.2</b> | <b>Mounting the Camera Without Accessories</b>                  | <b>72</b>  |
| 2.2.1      | Mounting Instructions   | 72         |
| 2.2.2      | Procedure   | 74         |
| <b>2.3</b> | <b>Mounting the Camera with the On-Wall Set</b>                 | <b>78</b>  |
| 2.3.1      | Mounting Instructions   | 78         |
| 2.3.2      | Procedure   | 81         |
| <b>2.4</b> | <b>Mounting the Camera with the In-Ceiling Set</b>              | <b>83</b>  |
| 2.4.1      | Mounting Instructions   | 83         |
| 2.4.2      | Procedure   | 86         |
| <b>2.5</b> | <b>Installing the Vandalism Set</b>                             | <b>88</b>  |
| 2.5.1      | Mounting Instructions   | 88         |
| 2.5.2      | Procedure   | 89         |
| <b>2.6</b> | <b>Installing the Wall Mount</b>                                | <b>91</b>  |
| 2.6.1      | Mounting Instructions   | 91         |
| 2.6.2      | Procedure   | 94         |
| <b>2.7</b> | <b>Installing the Corner and Pole Mount</b>                     | <b>96</b>  |
| 2.7.1      | Mounting Instructions   | 96         |
| 2.7.2      | Mounting to a Pole  | 98         |
| 2.7.3      | Mounting to a Wall or Building Corner                           | 99         |
| 2.7.4      | Mounting the Wall Mount to the Corner and Pole Mount            | 100        |
| <b>2.8</b> | <b>Replacing the MicroSD Card</b>                               | <b>101</b> |
| 2.8.1      | Removing the MicroSD Card                                       | 101        |
| 2.8.2      | Inserting a MicroSD Card  | 102        |
| <b>2.9</b> | <b>Network And Power Connection</b>                             | <b>103</b> |
| 2.9.1      | Notes on Cable Lengths and Power Supply                         | 103        |
| 2.9.2      | Connecting the Q25M to the Network Using a Patch Cable          | 103        |
| 2.9.3      | Power Supply Using a Switch                                     | 104        |
| 2.9.4      | Power Supply When Connected Directly to a Computer              | 105        |
| 2.9.5      | Power Supply with Power-Over-Ethernet Products                  | 105        |

|            |   |            |
|------------|---|------------|
| 2.9.6      | Connecting a USB Cable  | 106        |
| 2.9.7      | Connecting a Two-Wire MxBus Cable                                   | 107        |
| 2.9.8      | Variable PoE  | 108        |
| 2.9.9      | Camera Startup Sequence   | 109        |
| <b>3</b>   | <b>Operating the Camera</b>   | <b>110</b> |
| <b>3.1</b> | <b>Manual and Automatic Operation – Overview</b>                    | <b>110</b> |
| 3.1.1      | Manually Using a Computer in the 10.x.x.x IP Address Range          | 111        |
| 3.1.2      | Automatically Using MxControlCenter or MxEasy                       | 112        |
| 3.1.3      | Automatically Using DHCP  | 113        |
| <b>3.2</b> | <b>First Images and the Most Important Settings</b>                 | <b>114</b> |
| 3.2.1      | Manually Setting Up the Network Parameters in a Browser             | 114        |
| 3.2.2      | First Images and the Most Important Settings in the Browser         | 116        |
| 3.2.3      | First Images and Network Parameter Configuration in MxControlCenter | 118        |
| 3.2.4      | First Images and Network Parameter Configuration in MxEasy          | 123        |
| 3.2.5      | Starting the Camera with the Factory IP Address                     | 126        |
| 3.2.6      | Starting the Camera with an Automatic IP Address (DHCP)             | 127        |
| <b>3.3</b> | <b>Virtual PTZ and Full Image Recording</b>                         | <b>128</b> |
| 3.3.1      | Preparing the Virtual PTZ Function                                  | 128        |
| 3.3.2      | Full Image Recording  | 130        |
| 3.3.3      | Special Q25M Configuration in the Browser                           | 132        |
| <b>3.4</b> | <b>MicroSD Card Recording</b>                                       | <b>139</b> |
| 3.4.1      | Introduction  | 139        |
| 3.4.2      | Formatting the MicroSD Card   | 141        |
| 3.4.3      | Activating MicroSD Card Recording                                   | 142        |
| 3.4.4      | Accessing Data on the MicroSD Card                                  | 143        |
| 3.4.5      | Deactivating Card Recording   | 143        |
| 3.4.6      | Using a MicroSD Card in a Different MOBOTIX Camera                  | 144        |
| 3.4.7      | Limitations on Warranty When Using Flash Storage Media              | 144        |
| <b>3.5</b> | <b>Configuration in the Browser</b>                                 | <b>145</b> |
| 3.5.1      | Overview  | 145        |
| 3.5.2      | General Browser Settings  | 147        |
| <b>3.6</b> | <b>Additional Notes</b>   | <b>149</b> |
| 3.6.1      | Weatherproofness  | 149        |
| 3.6.2      | Password for the Admin Menu   | 149        |
| 3.6.3      | Permanently Deactivating the Microphone                             | 149        |
| 3.6.4      | Starting the Camera with the Factory IP Address                     | 149        |
| 3.6.5      | Resetting the Camera to Factory Settings                            | 150        |
| 3.6.6      | Activating Event Control and Motion Detection                       | 150        |
| 3.6.7      | Deactivating Text and Logo Options                                  | 150        |
| 3.6.8      | Deactivating the Camera Reboot                                      | 150        |
| 3.6.9      | Browser   | 151        |

|        |                              |     |
|--------|------------------------------|-----|
| 3.6.10 | Cleaning the Camera and Lens | 151 |
| 3.6.11 | Legal Notes                  | 151 |
| 3.6.12 | Safety Warnings              | 151 |
| 3.6.13 | Online Help in the Browser   | 152 |
| 3.6.14 | Declaration of Conformity    | 153 |
| 3.6.15 | Disposal                     | 153 |
| 3.6.16 | Disclaimer                   | 153 |

## Manufacturer

155



### Legal Notes

**Legal aspects of video and sound recording:** You must comply with all data protection regulations for video and sound monitoring when using MOBOTIX products. Depending on national laws and the installation location of the Q25M, the recording of video and sound data may be subject to special documentation or it may be prohibited. All users of MOBOTIX products are therefore required to familiarize themselves with all valid regulations and comply with these laws. MOBOTIX AG is not liable for any illegal use of its products.



**Safety Warnings**

**Installation Instructions:**

- This product must not be used in locations exposed to the dangers of explosion.
- Make sure to install this product as shown in *Chapter 2, «Installation»* of this manual.
- When installing this product, make sure that you are only using genuine MOBOTIX parts and MOBOTIX connection cables.
- Make sure that you are installing this product on a solid surface that provides for a sturdy installation of the fixing elements used.

**Electrical installation:** Electrical systems and equipment may only be installed, modified and maintained by a qualified electrician or under the direction and supervision of a qualified electrician in accordance with the applicable electrical guidelines. Make sure to properly set up all electrical connections.

**Electrical surges:** MOBOTIX cameras are protected against the effects of small electrical surges by numerous measures. These measures, however, cannot prevent the camera from being damaged when stronger electrical surges occur. Special care should be taken when installing the camera outside of buildings to ensure proper protection against **lightning**, since this also protects the building and the whole network infrastructure.

**Max. power consumption of attached extension modules:** The power consumption of all attached **MxBus modules** must **not exceed 2.5 W**. When attaching modules to the MxBus connector **and** the USB connector, the **power consumption of all attached modules must not exceed 3 W, if the camera is powered by PoE class 3**. If **PoE class 2** is used, **the power consumption of all attached modules must not exceed 1 W!**

**Never touch the lens:** Due to the high performance of the Q25M, the area of the image sensor **can get quite hot**, especially when the ambient temperature is also high. This does not affect the proper functioning of the camera in any way. For this reason, the product must not be installed within the reach of persons without the dome.

**Power off before opening the camera:** Make sure the power supply is disconnected before opening the camera (i.e., for installing or replacing sensor modules and SD cards).

**Network security:** MOBOTIX products include all of the necessary configuration options for operation in Ethernet networks in compliance with data protection laws. The operator is responsible for the data protection concept across the entire system. The basic settings required to prevent misuse can be configured in the software and are password-protected. This prevents unauthorized parties from accessing these settings.



## FOREWORD

Dear MOBOTIX customer,

Congratulations on your decision to purchase a professional and modern HiRes network camera "Made in Germany"! The Q25M provides 360-degree overview with only one hemispherical lens. This means that you only need one camera to monitor the entire room right into all four corners. The fisheye distortion that is typical for this kind of lens is automatically corrected by the camera software in the live image. Add to that the proven advantages that are inherent to the MOBOTIX concept, such as the integrated event, alarm and telephone features and the modern long-term storage directly in the camera with all of its benefits.

The weatherproof MxBus and MiniUSB interfaces of the camera allow attaching MOBOTIX interface boxes and standard devices, such as 3G/UMTS modems, external storage devices, etc. The integrated 4 GB SD card flash storage is easily exchanged for larger storage requirements, providing for secure long-term storage.

The introduction of the newest five-megapixel sensor technology with increased light sensitivity not only generates more brilliant images with more details, it also delivers color images of higher quality under lowlight conditions. Another improvement – The Q25M-Basic now generates HD images (1280 x 720 pixels) instead of the VGA images of predecessor models (640 x 480 pixels).

You can download the **MxEasy** and **MxControlCenter** video management software for MOBOTIX cameras and the manuals from the MOBOTIX website: [www.mobotix.com](http://www.mobotix.com) > **Support > Software Downloads**. For the iPad, iPhone and iPod touch iOS devices, MOBOTIX offers the **MOBOTIX App**, a free-of-charge mobile solution that is easily found when searching for "MOBOTIX AG" in the App Store.

If you have any questions, our support and international sales staff are available at [intl-support@mobotix.com](mailto:intl-support@mobotix.com) from Monday to Friday, 8 am to 6 pm (German time).

We would like to thank you for your trust and wish you all the best with your new MOBOTIX camera Q25M Hemispheric!



Security-Vision-Systems







## 1 PRODUCT OVERVIEW

### 1.1 Q25M Hemispheric



#### 1.1.1 General Product Characteristics

##### Innovative Hemispherical Technology for the Perfect Room Overview

The MOBOTIX Q25M Hemispheric camera is an elegant, ultra-compact and weatherproof IP network dome camera with a special hemispheric lens (fisheye). When mounted on the ceiling, the camera is capable of providing full **360° allround view** or a **180° widescreen panorama** when mounted on a wall. The first of its kind in the world, this camera is evidence of the MOBOTIX commitment to innovation as the global leader in megapixel video security cameras.

##### High-Resolution 180° Panorama (Wall-Mounted)

When several cameras are monitoring a single room, it is difficult to understand the room layout in its single view. This makes it hard to comprehend the overall setting. The new panorama function of the Q25M delivers a widescreen image of a high-resolution 180° allround view. High image quality is achieved through the use of a five-megapixel sensor and the new hemispheric lens.

Original Q25M image;  
Wall mounted at a height  
of 2.3 m in a bank



Original full image



**Panorama Focus – One Camera, Three Views (Wall-Mounted)**

Maximum room overview while simultaneously viewing detail in a single image: the Q25M is capable of providing two more views at the same time with the 180° panorama, allowing you to focus on two scenes in parallel ("Panorama Focus" display mode).

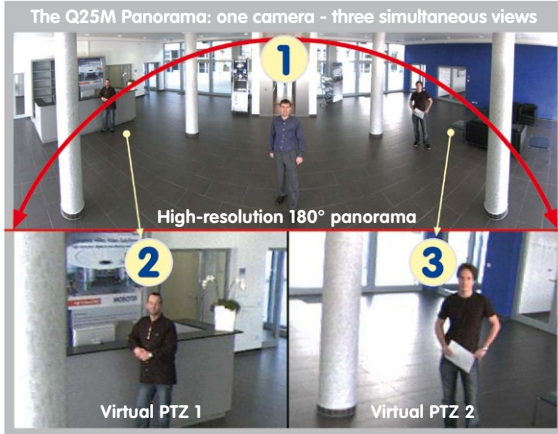

Panorama Focus:  
Original Q25M image



Original full image

**Double Panorama for a Simultaneous View in Two Directions (Ceiling-Mounted)**

When the camera is mounted in the center of the ceiling of a room, "Double Panorama" display mode provides a corrected panorama image of both halves of the room. It corresponds roughly with the situation of personally standing in the middle of the room and being able to look both forwards and backwards at the same time. A superb overview for the user – provided by a single Q25M camera alone.



Double Panorama:  
Original Q25M image



Original full image

### Full Image and Normal View

With innovative MOBOTIX Hemispheric Technology, an entire room can be ideally monitored. For instance, one single, particularly elegant and discreet, Q25M replaces the time-consuming and expensive installation of several standard cameras. The overview image provided by a single Q25M, which may be tailored in a number of ways according to specific user requirements, not only reduces the number of required cameras, but also minimizes the system costs by reducing the wiring complexity, emergency power requirements and number of recording devices required.

In addition to Panorama, Double Panorama and Panorama Focus views, the Q25M image may be displayed on a monitor in the original fisheye version ("Full Image" display mode), the camera-corrected full image ("Normal" display mode) and in a quad view of all four directions ("Surround" display mode). Switching to a different display mode is possible at any time within seconds.



**Surround View (Quad View), Based on the Correct Full Image**

The Q25M "Surround" display mode replaces (when ceiling mounted) four cameras, and shows four directions simultaneously on the monitor in a quad view. The preset North position can be moved to any direction in the image; the camera generates the other three directions (East, South, West) automatically and stores them as separate views.

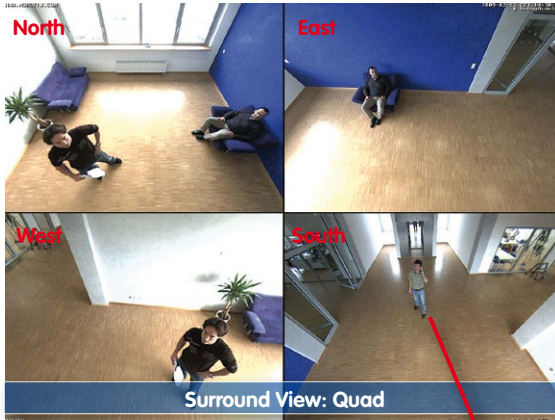

Original Q25M image:  
Each of the 4 views can  
be individually modified

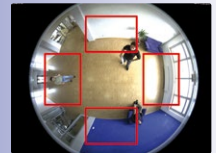

Original full image

Each of the four views features a software-controlled pan/tilt/zoom function (virtual PTZ), allowing it to be customized as necessary.

In order to reduce user workload, the Q25M can store in addition to the North, East, South and West standard views, a total of **256 user-defined camera views using the vPTZ function**, which can easily be brought up using joystick keys or softbuttons. Besides being able to manually bring up specific camera views, the camera can also show them automatically by moving through the North, East, South and West views or by showing the first 16 saved camera views (one after the other like in a slide show).

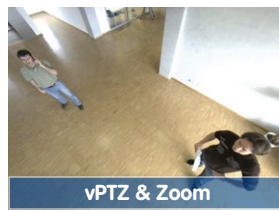

**Complete HiRes Video Solutions by MOBOTIX**

As opposed to conventional solutions, MOBOTIX cameras with their decentralized approach offer so much more – state-of-the-art, network-based video security technology that increases operating efficiency and yields a high degree of every-day usefulness.

### Extraordinary Picture Quality

Image quality is the one key criterion of a security camera. Due to their internal video analysis and data storage capabilities, the decentralized MOBOTIX systems are independent of the available network bandwidth. As a result, the system provides for efficiently storing and managing the video streams of a virtually unlimited number of cameras with the highest resolution at a reasonable cost.

### Five-Megapixel Image Sensors (5MP)

MOBOTIX cameras possess high-resolution image sensors with 5 megapixel resolution and excellent light sensitivity, which translates into more details when zooming and more clear-cut advantages for every user. By using the 5MP technology in their color and black&white image sensors, MOBOTIX cameras deliver convincing image quality and details even in bad weather and under lowlight conditions. Another important plus: thanks to its internal pre-processing of the image data, the camera can generate video streams with up to 30 frames per second.

### QXGA Image Format: 2.5 Times More Detail Than Full HD

The 5MP sensor has a resolution of 2592 x 1944 pixels on both day and night sensors. While the image sensor shows its full strength when zooming the live image, the maximum image size per sensor has the more user-friendly QXGA format.

### Low Light Conditions – No Problem

The maximum resolution of the color and black&white image sensors is 5 megapixels. The higher light sensitivity of the new color image sensors now allow using MOBOTIX color cameras around the clock even when the illumination is low.

### MxLEO: Exposure Optimization and Reduced Image Noise

MxLEO – the MOBOTIX Lowlight Exposure Optimization – is an innovative technology that provides an entirely new experience in digital image optimization in all cameras running firmware 4.1.9 and higher. On the one hand, the improved light sensitivity of the MOBOTIX 5MP sensors drastically reduces exposure times. MxLEO, the exposure and image optimization program especially developed for these conditions, on the other hand, generates perceptibly better and more detailed images especially under low-light conditions below 25 Lux. Such conditions are typical at a parking lot at night that is illuminated by regular lights (approx. 10 to 25 Lux). Or in a building after hours, in which the emergency lights are burning (approx. 5 Lux). This significantly reduces motion blur that is typical of longer exposure times with little light and thus provides much more image detail (faces, license plates, etc.) for proper identification.

## Virtual PTZ (vPTZ) – No Motor Required



The Q25M can zoom in on detail as well. These vPTZ functions are a standard feature in the integrated Q25M camera software. The image from the hemispheric camera can be enlarged using e.g. the mouse wheel, a joystick or a software-controlled PTZ panel, and you can "move" the view to any section of the image. This provides the features of a mechanical PTZ camera without the disadvantages of maintenance and wear.

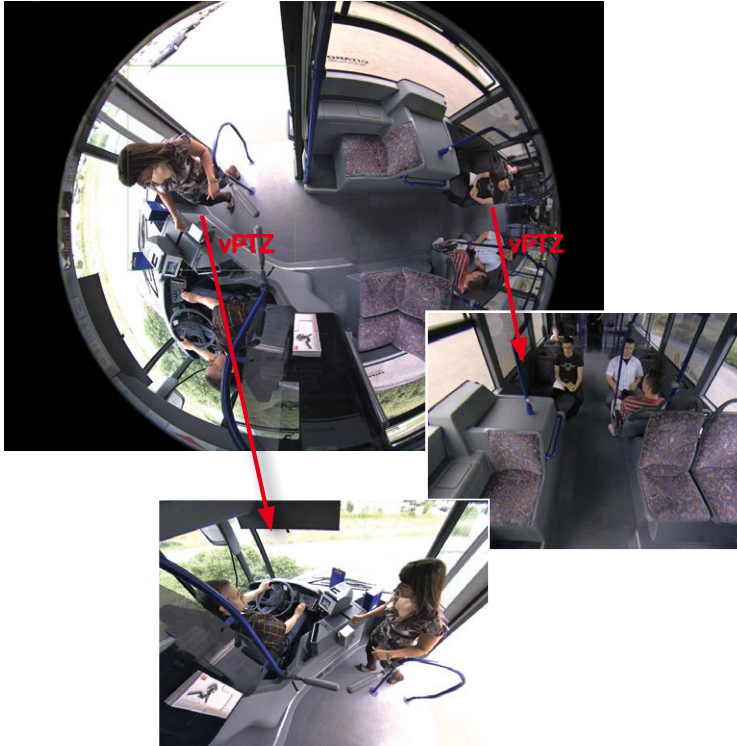

Quick and easy navigation with a USB joystick

The vPTZ functionality works differently depending on the camera operation platform (**web browser, MxEasy, MxControlCenter**). Virtual zoom, pan and tilt using MxEasy and MxControlCenter is very simple thanks to special software tools and the use of an optional joystick. However, a joystick may also be used even with pure browser-based operation from Internet Explorer (together with an ActiveX plug-in).

### Simultaneous Corrected Live Image and Full Image Recording

All conventional, motorized PTZ cameras only store the image that is currently viewed as the live image (**live image recording**). This has one serious disadvantage as the recording can only show what has happened in the "visible" portion of the image; the rest is lost and cannot be examined later on. For this reason, MOBOTIX has added the new **full image recording** feature to the Q25M. This will not store the currently viewed image that reflects the pan/tilt position and the zoom setting chosen by the user, but the full sensor image - without vPTZ settings or image correction. When examining the recorded images, the vPTZ features again come into play, as they allow zooming the visible image and use the pan/tilt features to examine every corner of the recorded full image.

Integrated vPTZ functions allow "analysis" of the complete saved full image at a later point in time (in MxEasy and MxControlCenter)

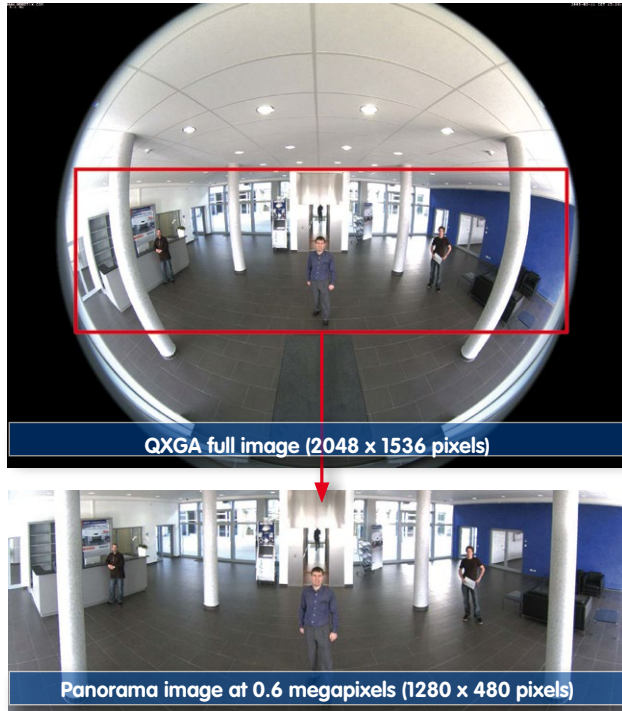



**Example:** The people marked by the red circle in the middle area of the image would not have been recorded by a regular PTZ camera; the full image recording of the Q25M allows to determine for example, the exact time at which the people entered the image area recorded by the camera. A **Browser** (Internet Explorer with MxPEG ActiveX plug-in), **MxControlCenter** or **MxEasy** can be used to examine the recorded sequences.

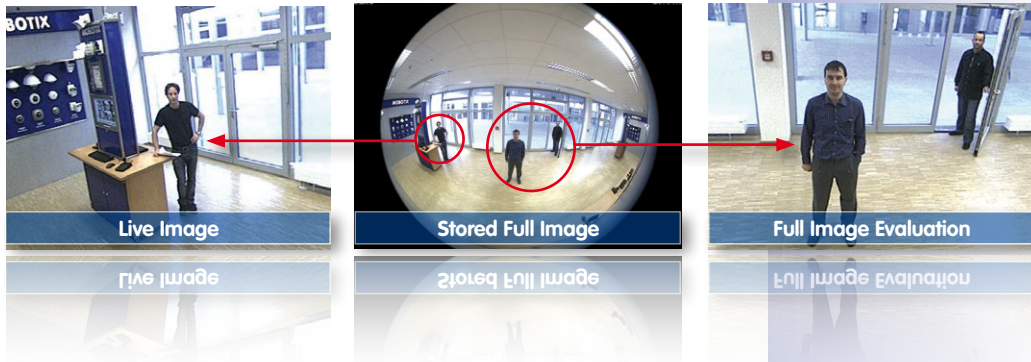

**Maximum Ease of Use**

The full image generated by the hemispherical lens (fisheye) can be difficult to evaluate. MOBOTIX solves this problem with image distortion correction in the camera software that displays perfectly corrected live images. The user PC does not experience any additional load through this process, as image correction and generation of all desired image views takes place in the camera itself. The result is that a large number of panoramic cameras may be displayed simultaneously on a single PC.

**Highly Efficient, Application-Oriented Image Transfer**

While other camera systems must transport the full QXGA image over the network for further processing, a MOBOTIX camera will only transmit the desired image sections. This means that a Q25M panorama image will only require a small part of the usual data and bandwidth. Data from up to six times as many MOBOTIX cameras may be transported over the same network compared to "standard" cameras.

The camera software is responsible for image correction, reducing load on the user PC

Corrected image after panorama correction

Economical bandwidth usage due to smaller, in-camera corrected images (no loss of image information)

4 GB MicroSD-card  
already installed in the  
camera (Q25M-Secure)

### Internal DVR

The Q25M secure models feature **direct recording to integrated MicroSD cards**, which makes the camera fully independent of any external storage media, even for longer periods of time. The camera internally saves high-resolution video with sound, without requiring an external storage device or PC, and thus without any network load whatsoever. Old recordings may be overwritten automatically or automatically deleted after a specified period of time. A 16 GB MicroSD card, for example, allows the camera to store more than a quarter million event images in VGA format (640x480). For security reasons, the camera can even encrypt the stored data.



Power failures are not an issue, as the video and image sequences remain safely stored on the MicroSD card. Access to stored video sequences is possible at any time from the camera user interface in the browser, MxControlCenter or MxEasy. If you would like to archive sequences, you can store all of the data or only certain parts to a computer or a hard disk.

### MxActivitySensor Video Motion Analysis: Secure Detection, Avoiding False Alarms

Regardless if there are large objects in the foreground or small objects in the background – MxActivitySensor will only trigger video recording and alarm messaging if something important is happening. Interference such as trees shaking in the wind, moving shadows and clouds and snow falling will no longer lead to false alarms. Since all of this is filtered automatically, all that remains is to set the direction of movement of objects that should trigger alarms.

### Camera Design Creates New Applications

Some application scenarios benefit from a surveillance camera that is present, but without attracting attention. The low-key, elegant appearance of the camera, especially when installed with the In-Ceiling set, makes the Q25M an optimum solution where discreet design and an inconspicuous look are important. Hotels and restaurants present an ideal example, but installations in public buildings, waiting rooms and showrooms are also highly suitable.

The integrated DVR functionality with long-term storage on a MicroSD card also makes the camera an ideal solution for **mobile applications** since it only requires a power supply via the network cable (standard PoE) for full event-driven recording with video and audio, thus delivering a complete **standalone product**. Application examples in this context are installations in public transportation such as busses, trains, aboard ships, airplanes, etc.



Q25M in the In-Ceiling Set (local public transport bus)



Q25M in the In-Ceiling Set with stainless steel ring (elevator)

### Model Versions

The Q25M is available in **Secure and Basic models**, which come with different features. Both models can also be ordered with an L25 Super Wide-Angle lens with a horizontal image angle of 82°.

Q25M with 10°  
On-Wall Set



Q25M with  
In-Ceiling Set



1.1.2 Hemispheric Technology

The Q25M Hemispheric offers all the image views known from MOBOTIX' other hemispheric cameras, including *Panorama*, *Panorama Focus*, *Double Panorama*, *Full Image*, *Normal* and *Surround*.

The primary components of a hemispheric camera include a fisheye lens, a high-resolution image sensor, and image correction software that is integrated into the camera. Using an ultra-wide angle lens, the hemispheric camera captures a 180°-hemispheric image of the room and projects it onto a high-resolution image sensor.

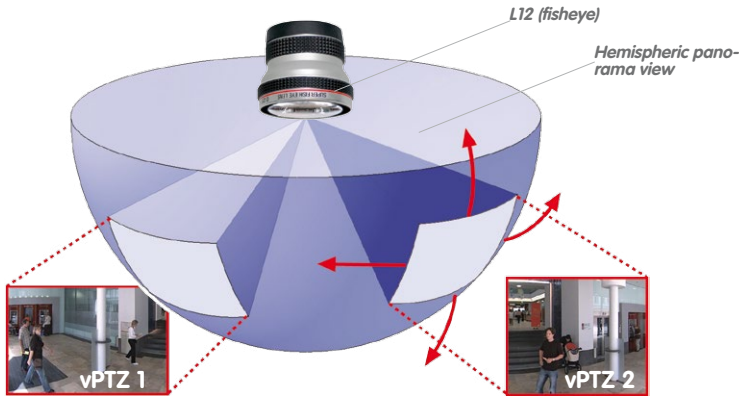

When ceiling mounted, the image area of the hemispheric camera covers the entire room. The image in the hemisphere is convex, particularly near the image borders. These image sections are corrected for the viewer by the integrated distortion correction software, allowing a view of the scene from the usual perspective. The virtual PTZ feature allows you to enlarge or move image sections within the hemisphere just like PTZ camera, yet without the need for mechanical moving parts. Hemispheric cameras lack mechanical moving parts and require low maintenance. In addition, they are silent when panning and focusing on a specific image area.

### Handling Several Image Sections at Once

One or more image sections can be corrected for perspective in the hemispheric view, allowing you to monitor and record several different areas of a room at the same time, something that a mechanical PTZ camera is not capable of doing.

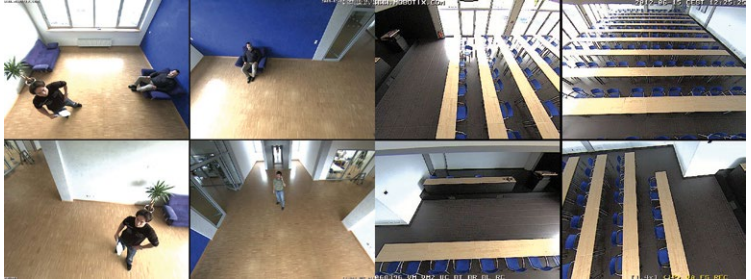

### Everything Stored in the Recording

Traditional optical PTZ cameras can only record what is being viewed live. The virtual PTZ feature from MOBOTIX allows users to pan to other areas at a later stage in the recording because the **entire room** can be recorded as a hemispheric image.

### Special Hemispheric Image Views

#### Panorama

The hemispheric image (original full image) can also be transformed into an ultra-wide angle panoramic view if the camera is mounted on a wall, providing a view of the room without any blind spots from wall to wall. It offers a substantially better view of the scene, compared to other cameras, and it also results in the need for fewer cameras overall.



**Panorama Focus**

Maximum room overview while simultaneously viewing detail in a single image. A hemispheric sensor module can also provide two additional views so that you can focus on two detail scenes simultaneously in addition to the panorama view.

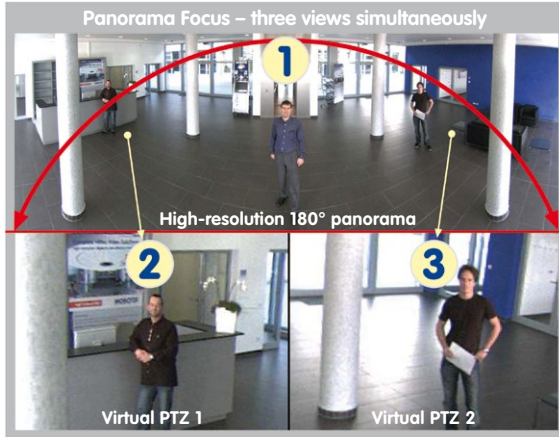

Original full image

**Double Panorama**

When the camera is mounted in the center of the ceiling in a room, the "Double Panorama" display mode provides a corrected panorama image of both halves of the room. It corresponds roughly to the situation of personally standing in the middle of the room and being able to look both forwards and backwards at the same time. This is a superb overview for the user – provided by a single sensor module.

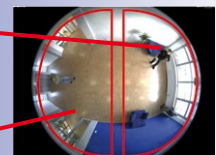
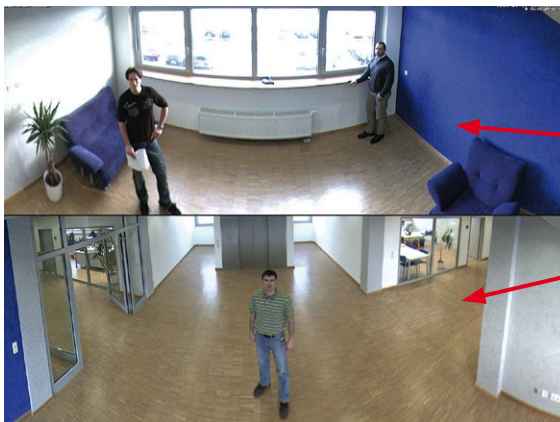

Original full image

### 1.1.3 Advantages and New Features

The high-resolution Q25M Hemispheric is a universally deployable, highly innovative and easily concealable camera system. A powerful successor to the Q24M, the Q25M features a five-megapixel image sensor. For technical reasons, the live or recorded images displayed by a Q25M sensor have a maximum size of QXGA. However, the Q25M is clearly superior to its predecessor in terms of image quality and frame rate.

#### Smooth HiRes Video Streams

The modified hardware of the Q25M transmits the camera's video streams even more smoothly than the high-performance Q24M, even when high resolution is required. Since image streams of 16 frames per second and higher are perceived as smooth video by the human eye, the maximum frame rate is limited to 30 frames per second (when using MEGA resolution of 1280 x 960) in order to provide sufficient camera processing power for other tasks.

#### Conclusive Still Images

Thanks to the proprietary MxPEG video codec developed exclusively for MOBOTIX cameras, the cameras offer the advantage that a recording can be paused at any given point and still provide meaningful and useful snapshots due to the absence of distortion. This is essential for security applications and allows individuals or license plates to be identified, for example. In contrast, the H.264 standard, which was developed for feature movies and is favored by some video security providers, cannot achieve this with the required level of quality.

#### Good Color Images Even in Low Light

The more light-sensitive an image sensor is, the better the image quality, especially when the ambient light level is low, such as at dusk and in heavy rainfall. The Q25M offers the best MOBOTIX image quality that is currently available thanks to the light sensitivity provided by the five-megapixel color sensor that is four times higher than that of the previously used 3.1-megapixel color sensor and the new MxLEO exposure control.

#### More Details When Zooming

The maximum zoom factor of the Q25M is 1.26 times higher than that of the Q24M due to the use of five-megapixel technology. This means that the degree of detail provided by the camera has improved by 26 percent. As a result, a Q25M can now be installed even further away than before from the objects and areas to be monitored. In addition, this offsets the slightly smaller horizontal image angles of the new five-megapixel sensors as compared to the Q25M.



### Black&White Image Sensor with Five Megapixels

You can now order the Q25M with a five-megapixel night sensor that can deliver black and white images with up to QXGA resolution. This results in larger images than those delivered by the previous 1.3-megapixel sensor with a perceptibly higher degree of details.

### Basic Cameras Maximum Image Size Is Now HD Instead of VGA

The Q25M-Basic now generates HD images (1280 x 720 pixels) instead of the VGA images of predecessor models (640 x 480 pixels). The special quality advantage of a MOBOTIX-Basic camera with HD resolution (1280 x 720): The HD images of a MOBOTIX are generated by the high-resolution image sensor with 2592 x 1944 pixels and are optimized and scaled down for the HD format. Because of the high-resolution sensor, the generated images – especially with respect to quality and light sensitivity – are noticeably superior than regular HD cameras that are only using a simple HD sensor with 1280 x 720 pixels.

### MxActivitySensor

The Q25M provides an activity-controlled image analysis sensor as standard for detecting the movements of people and objects in a defined surveillance area (full image or section). The MxActivitySensor delivers reliable results particularly in outdoor area applications, in contrast to video motion detection that continues to be available and that registers all image changes in defined video motion windows. In the monitored area, the camera distinguishes between the continuous movements of vehicles, persons or objects that trigger an alarm and movements that do not set off an alarm such as shadows, changing light conditions and trees swaying in the wind.

### Low Power Consumption in Accordance with the PoE Standard (IEEE 802.3af)

A Q25M uses no more power than its predecessor (typically 4.5 watts), despite the new sensor technology. Adjusting the PoE class via the camera software also enables the use of PoE switches that cannot be operated on all ports with PoE class 3 (up to max. 12.95 V).



### 1.1.4 Decentralized Video System

Usually, cameras only supply images, while processing and recording take place later on a central PC using video management software. This centralized structure has too many limitations for high-resolution video systems since it requires high network bandwidth and the PC processing power is insufficient when using several high-resolution cameras. Due to the large number of computers and servers required, traditional centralized systems are therefore becoming less suitable and cost effective.

As part of the decentralized MOBOTIX concept, every camera features a **high-speed processor**, and, if necessary, digital **long-term flash memory** (MicroSD card) can be integrated to provide several days of recording time. The computer or video control center is required only to view and control the cameras, not to evaluate and record video. This means that you do not have to rely on expensive, overloaded video management software as most of the important functions that require a large amount of processing power are integrated into the MOBOTIX cameras themselves.

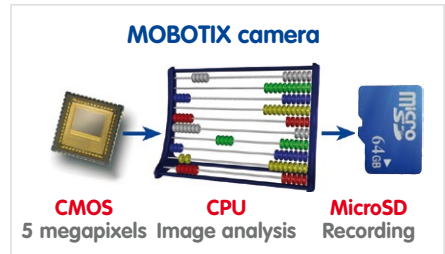

**Integrated sensors** enable MOBOTIX cameras such as the Q25M to automatically detect when an event has occurred. If necessary, the cameras will respond immediately with an alarm sound and will establish a direct video and sound connection to a control room.

The Q25M is equipped with a **shock detector** as standard (for all IT and Secure models). For example, if the camera receives a blow to the housing, it can simultaneously take a video of the offender, trigger a sound alarm and notify the security company by a SIP call. Due to the build quality and absence of moving parts, MOBOTIX cameras are extremely tough. This typically allows them to stay fully operational especially when they are subject to strong vibrations.

All MOBOTIX cameras are **backlight-proof** and are not adversely affected by the glare from direct sunlight. They deliver meaningful, detailed images at all times as the camera software supports easy programming of independent exposure windows, making them ideal for rooms with large glass fronts.

In the event of an alarm, MOBOTIX Q25M cameras can also record **lip-synchronous audio**. The cameras therefore play an important role in analyzing and clarifying a situation. Thanks to an integrated speaker and microphone, each individual camera can also be used for **bidirectional communication** (two-way video communication), so you can easily use the MOBOTIX App with your iPhone or iPad on the road.

The decentralized **MOBOTIX video solutions** are superior to traditional systems in all major aspects. They are also considerably cheaper to operate since they require

- **Fewer cameras** due to the more accurate detail of panorama images with megapixel technology
- **Fewer recording devices** because in the decentralized system, ten times the standard number of cameras can be used to record high-resolution HDTV video with sound on one computer/server simultaneously
- **Lower network bandwidth** because everything is processed in the camera itself and the high-resolution images therefore do not have to be constantly transported for analysis



### MOBOTIX System

Decentralized and secure



Recording software



PC as storage device



### 1.1.5 Green IP Video

The modern, network-based video security technology offers numerous advantages to use energy efficiently. Due to the special product and system properties, the decision to install MOBOTIX video systems is also a decision for Green IP Video: low power consumption and environmental friendly because of long life expectancy and minimal amount of materials involved.

#### Low Power Consumption

MOBOTIX cameras are cost-efficiently supplied via PoE. This reduces the expenses for power and, in addition, saves copper and other important raw material as less power cabling is necessary.

#### Robust

MOBOTIX IP65 cameras are highly robust and work – without high-power climate control and extra protective housing – in a temperature range from  $-30$  to  $+50^{\circ}\text{C}/-22$  to  $+122^{\circ}\text{F}$ .

#### Modern

Integrated into the cameras are high-power processors and flash storage, thus making energy-consuming servers and storage devices unnecessary. And, of course, the disposal of waste later.

#### High Resolution

A hemispheric MOBOTIX camera with two image sensors replaces up to eight standard cameras – including their consumption of energy and resources.

#### Sustainable

Without mechanical components, MOBOTIX cameras are maintenance-free and stay fully functional, even after years – and are, thus, more sustainable compared to other systems.

#### Forward-Looking

Even previous camera models can be easily updated and then offer new functionalities. Remote updates via the internet and the fact that the cameras are maintenance-free reduce trips by car, and, thereby, the negative effect on the environment.





## 1.2 Technical Specifications

### 1.2.1 Lens Options

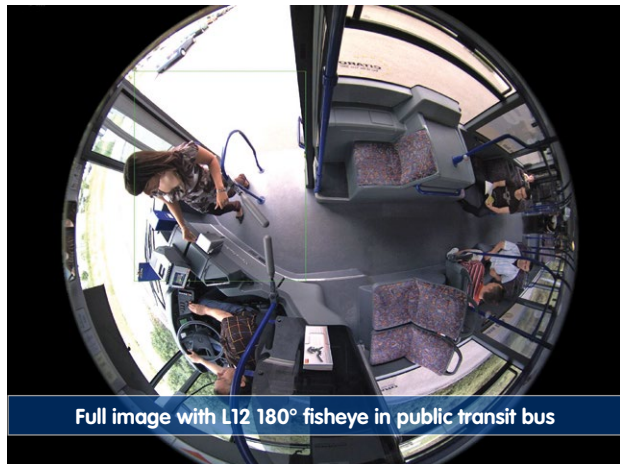
MOBOTIX Q25M cameras come with a standard **L12 fisheye lens with a 180° horizontal image angle**. The camera is also available with an **L25 Super Wide-Angle lens with a horizontal image angle of 82°**. The integrated virtual PTZ features of the camera software or MxControlCenter/MxEasy properly correct the lens distortion that is specific to each of the lenses. Both lenses deliver good image quality even when using maximum digital zoom. Since MOBOTIX cameras are backlight-proof, they do not require a mechanical auto iris, making them extremely robust and maintenance free.



| Lens Options            | L12   | L25   |
|-------------------------|---|---|
| Original image          |  |  |
| 35 mm equivalent        | 12 mm   | 25 mm   |
| Nominal focal length    | 1,8 mm  | 4 mm  |
| Aperture                | 2,0   | 2,0   |
| Horizontal image angle  | 180°  | 82°   |
| Vertical image angle    | 160°  | 61°   |
| <b>At 1 m distance</b>  |   |   |
| Image width             | infinite  | 1,7   |
| Image height            | 11  | 1,2   |
| <b>At 5 m distance</b>  |   |   |
| Image width             | infinite  | 8,7   |
| Image height            | 55  | 5,9   |
| <b>At 10 m distance</b> |   |   |
| Image width             | infinite  | 17,4  |
| Image height            | 110   | 11,9  |
| <b>At 20 m distance</b> |   |   |
| Image width             | infinite  | 34,7  |
| Image height            | 220   | 23,7  |

**Notes**

The specified focal lengths of the MOBOTIX lenses do not reflect the actual focal length of the lenses, but the focal length (Lxx mm) converted to 35 mm camera format. For example, the MOBOTIX L25 Super Wide-Angle lens has an actual focal length of 4 mm. This would be the equivalent of 25 mm on a 35 mm camera. It is therefore referred to as an L25. Since the image sensors in digital cameras have different sizes, converting the focal lengths to 35 mm camera as a known format allows the image formats and the fields of vision of the different lenses to be calculated and compared more easily. Another benefit is that you can easily set a 35 mm camera (analog or digital) to the same focal length as the MOBOTIX lens (Lxx) to obtain the same field of vision. This approach greatly facilitates lens selection.



The focal lengths of MOBOTIX camera lenses refer to standard 35 mm cameras

## 1.2.2 Camera Variants – Lenses, Hardware, Image Formats

| Camera Model  |  |  |
|---|---|---|
|   | <b>Q25M-Basic</b>   | <b>Q25M-SEC</b>   |
| <b>Lenses, Sensors</b>                              |   |   |
| 12 mm Hemispheric                                   | L12   | L12   |
| Super Wide-Angle 25 mm                              | L25   | L25   |
| Wide-Angle 38 mm                                    | –   | –   |
| Wide-Angle 51 mm                                    | –   | –   |
| Tele 76 mm  | –   | –   |
| Tele 160 mm   | –   | –   |
| CSVario 24 – 54 mm                                  | –   | –   |
| Image sensor with individual exposure zones         | Color   | Color/BW  |
| Sensor sensitivity in lux at 1/60 s and 1 s         | 0.25 / 0.013  | 0.25 / 0.013 (Color)<br>0.05 / 0.0025 (BW)  |
| <b>Hardware Features</b>                            |   |   |
| IP protection class                                 | IP54  | IP65  |
| Temp. Internal DVR (MB)                             | 2   | 64  |
| Internal DVR (MicroSD, up to 64 GB)                 | –   | 4 GB included   |
| Microphone/speaker                                  | –/•   | •/•   |
| Passive infrared sensor (PIR)                       | –   | –   |
| Integrated temperature sensor                       | •   | •   |
| Shock detector                                      | –   | •   |
| Power consumption in watts (typical)                | < 4.5   | < 4.5   |
| Variable PoE class                                  | 2 – 3   | 2 – 3   |
| <b>Image Formats, Frame Rates and Image Storage</b> |   |   |
| Max. image size                                     | <b>HD</b> (1280x720)  | <b>QXGA</b> (2048x1536)   |
| Max. frame rate (MxPEG, max. resolution)            | 30 fps  | 20 fps  |
| CIF images with 4 GB MicroSD DVR                    | –   | 250,000   |
| VGA images with 4 GB MicroSD DVR                    | –   | 125,000   |
| MEGA images with 4 GB MicroSD DVR                   | –   | 40,000  |
| QXGA images with 4 GB MicroSD DVR                   | –   | 20,000  |



1.2.3 Camera Variants – Software Features

| Camera Model   |  |  |
|--|---|---|
|  | <b>Q25M-Basic</b>   | <b>Q25M-SEC</b>   |
| <b>General Features</b>  |   |   |
| Digital zoom (continuous) with panning   | •   | •   |
| Motion JPEG/MxPEG/H264 codecs  | •/•/–   | •/•/• (SIP video only)  |
| Programmable exposure ones   | •   | •   |
| Snapshot rec. (pre-/post-alarm images)   | 3   | 50  |
| Terabyte ring buffer storage (internal/network)  | –   | •   |
| Continuous rec. with sound (0.2 to 30 fps)   | –   | •   |
| Event recording with sound   | –   | •   |
| Time and event control   | •   | •   |
| Weekly schedules/holidays  | –   | •   |
| Web functionality (FTP, email)   | •/•   | •   |
| Playback/Quad- und MultiView   | •   | •   |
| Bidirectional sound in browser   | –   | •   |
| Logo generator, animated   | –   | •   |
| Flexible event logic   | –   | •   |
| Master/Slave arming  | –   | •   |
| Several scheduled privacy zones  | –   | •   |
| Customized voice messages  | –   | •   |
| VoIP telephony (audio/video, alert)  | –   | •   |
| Remote alarm notification (network msg.)   | –   | •   |
| Signal inputs/outputs, RS232   | –   | Via MX-232-IO-Box   |
| Programming interface/HTTP API   | –   | •   |
| Security features (HTTPS/SSL, IP-based access control, IEEE 802.1X network authentication) | •   | •   |
| <b>Video Analysis</b>  |   |   |
| Video Motion detector  | –   | •   |
| MxAnalytics  | –   | –   |
| MxActivitySensor   | –   | •   |
| <b>Video Management Software</b>   |   |   |
| MxEasy, MxCC   | •   | •   |
| MOBOTIX App  | •   | •   |

Free-of-charge download from [www.mobotix.com](http://www.mobotix.com) or App Store

## 1.2.4 Technical Data

| Technical Data Q25M   |   |
|---|---|
| <b>Model variants</b>   | MX-Q25M-Basic,<br>MX-Q25M-SEC, MX-Q25M-SEC-Night  |
| <b>Lens options</b>   | 12 to 25 mm format,<br>horizontal angle 180° to 82°   |
| <b>Sensitivity</b>  | Color sensor: 0.25 lux at 1/60 s, 0.013 lux at 1 s<br>Black and white sensor: 0.05 lux at 1/60 s,<br>0.0025 lux at 1/1 s<br>MxLEO – MOBOTIX Lowlight Exposure Optimization  |
| <b>Image sensor</b>   | 1/2.5" CMOS , 5 megapixels, progressive scan  |
| <b>Max. image size</b>  | Color/Black and white: 2048x1536 (QXGA)   |
| <b>Image formats</b>  | 2048x1536 (QXGA), 1920x1080 (full HD), 1280x960 (MEGA), 1280x720 (HD), 1024x768, 800x600, 768x576 (D1-PAL), 704x576 (TV-PAL), 640x480, 384x288, 320x240, 160x120, custom formats  |
| <b>Max. frame rate M-JPEG (live/recording)</b>                    | VGA: 30 fps, MEGA: 10 fps, QXGA: 4 fps  |
| <b>Max. frame rate MxPEG (live and recording including sound)</b> | VGA: 30 fps, MEGA: 30 fps, QXGA: 20 fps   |
| <b>Image compression</b>  | MxPEG, M-JPEG, JPEG, H.264 (SIP video only)   |
| <b>Internal DVR</b>   | MicroSD slot including 4 GB, max. 64 GB   |
| <b>External video ring buffer</b>                                 | Directly on NAS and computer/server without additional recording software   |
| <b>Software (included)</b>  | MxEasy video management software,<br>MxControlCenter control center software,<br>MOBOTIX App for iOS devices with iOS 5.0 and higher  |
| <b>Image processing</b>   | Backlight compensation, automatic white balance,<br>image distortion correction, panorama correction,<br>Video Motion detection, MxActivitySensor   |
| <b>Virtual PTZ</b>  | Digital pan/tilt/zoom, continuous 8X zoom   |
| <b>Alarm/events</b>   | Video Motion detection, MxActivitySensor, external signal, temperature sensor, PIR, microphone, shock detector, notification over e-mail, FTP, IP telephony (VoIP, SIP), visual/acoustic alarms, pre- and post-alarm images |
| <b>Mikrophone and speaker</b>                                     | Microphone and speaker integrated   |
| <b>Audio features</b>   | Lip-synchronous audio, two-way communication, audio recording   |
| <b>Interfaces</b>   | 10/100 Ethernet, IPv4/IPv6, MiniUSB, MxBus; inputs/outputs and RS232 via accessories  |
| <b>Video telephony</b>  | VoIP/SIP, two-way communication, remote controlling with key code, event notification   |

Functionality depends on camera variant (see Section 1.2.3, «Camera Variants - Software Features»)

| Technical Data Q25M                             |   |
|---|---|
| Security  | User/group management, HTTPS/SSL, IP address filter, IEEE 802.1x, intrusion detection, digital image signature  |
| Certifications                                  | EMC (EN 55022, CISPR 22, EN 55024, EN 61000-6-1/2, FCC part15B, CFR 47, AS/NZS 3548)  |
| Power supply                                    | Year-round Power-over-Ethernet (IEEE 802.3af); variable PoE class, approx. 4.5 W  |
| Operating conditions                            | IP65, -30 to +50°C/-22 to +122°F  |
| Dimensions/weight Q25M without mounting options | Diameter x H: 160 x 48 mm (on-wall installation); weight: approx. 450 g/1 lb (including lens)   |
| Delivered parts                                 | Housing (high-resistance composite, PBT), white, mounting parts, Allen wrench, 50 cm patch cable, manual, software, 4 GB MicroSD card (only Secure models, pre-installed) |



### 1.3 Delivered Parts and Dimensions

#### 1.3.1 Q25M Camera



| Item | Quantity | Part Name  |
|------|----------|--|
| 1.1  | 1        | Camera   |
| 1.2  | 1        | Lens   |
| 1.3  | 1        | Lens wrench  |
| 1.4  | 1        | MicroSD card (4 GB)*, pre-installed                      |
| 1.5  | 1        | CAT5 patch cable, 0.5 m incl. washer, pre-installed      |
| 1.6  | 1        | Allen wrench 3 mm  |
| 1.7  | 1        | Allen wrench 2 mm  |
| 1.8  | 1        | Torx wrench  |
| 1.9  | 1        | Outer shell  |
| 1.10 | 1        | Mounting ring  |
| 1.11 | 4        | Universal screw anchors 8 mm                             |
| 1.12 | 4        | Stainless steel washers Ø 5,3 mm                         |
| 1.13 | 4        | Stainless steel wood screws with hex head 4.5x60 mm      |
| 1.14 | 4        | Stainless steel Allen screws M4x16 mm                    |
| 1.15 | 4        | Stainless steel washers Ø 4.3 mm                         |
| 1.16 | 2        | Cable retainer with bayonet catch (patch cable, MiniUSB) |

\*MicroSD card only available for Q25M-Secure

## Camera Housing and Connectors

The MOBOTIX Q25M consists of the camera housing (motherboard and lens), the outer shell and the mounting ring.

## Connections

- NET (Ethernet network incl. PoE power supply)
- MiniUSB (e.g. for ExtIO)
- Slot for MicroSD card

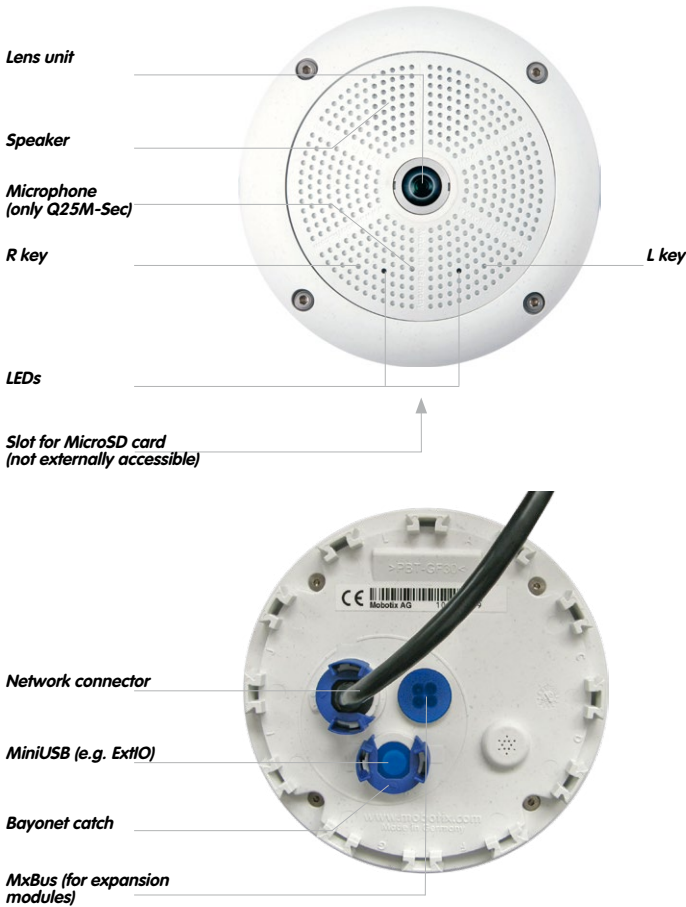

## Q25M: Dimensions Without Mounting Options



## Mounting Ring Drilling Template (Incl. Space For Wall Outlet)

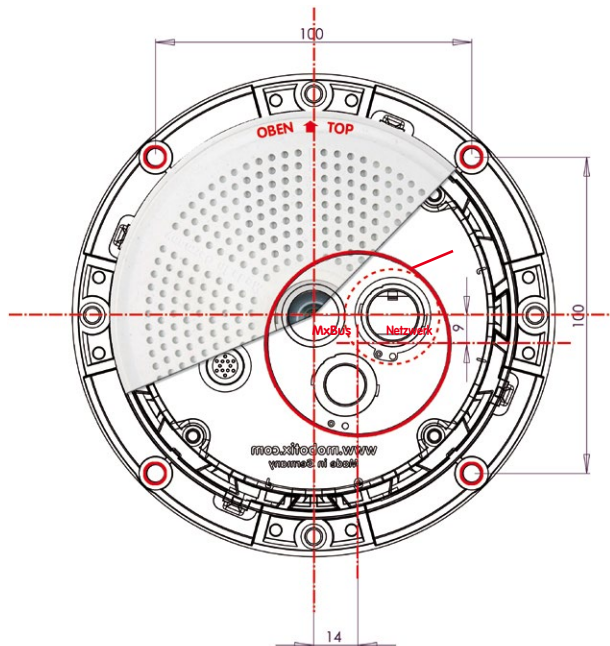

Find the drilling templates (scale 1:1) at the end of the manual as a fold-out

The blue circle indicates the hole to cut for the wall outlet

## Note

Find the folded drilling template at the end of the manual.

Make sure that the drilling template is not scaled or adjusted to the paper size when printing the PDF file (enlarged or reduced).

1.3.2 Mounting Kits and Mounts

On-Wall Set



The On-Wall Set must be ordered separately from the MOBOTIX camera.

| Item | Quantity | Part Name                                      |
|------|----------|--|
| 2.1  | 1        | On-Wall set housing                            |
| 2.2  | 4        | Stainless steel Allen screws M4x35 mm          |
| 2.3  | 4        | Stainless steel washers Ø 4.3 mm               |
| 2.4  | 4        | Foam rubber washers                            |
| 2.5  | 4        | Lock screws with counter nuts                  |
| 2.6  | 2        | Cable fitting with counter nut and O-ring cord |

## Drilling Template On-Wall Set

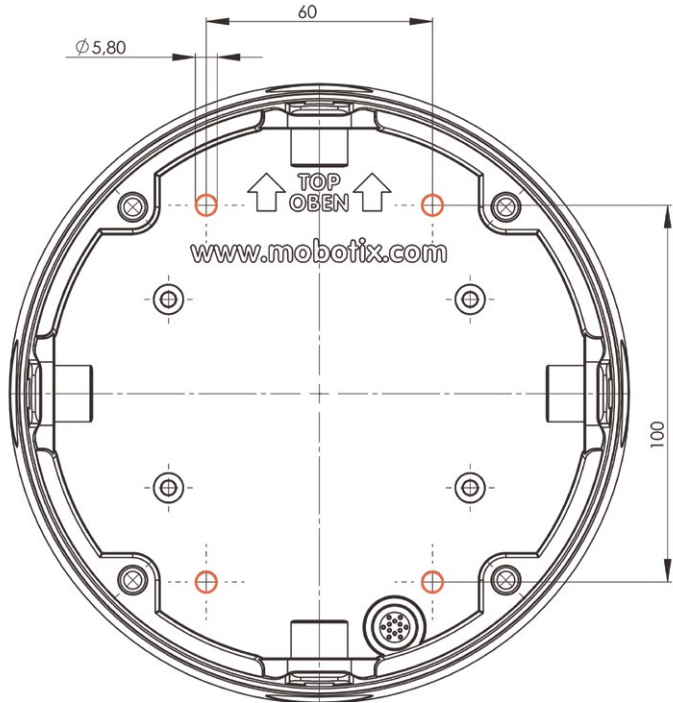

Find the drilling templates (scale 1:1) at the end of the manual as a fold-out



ø 160 mm / 6.3 in

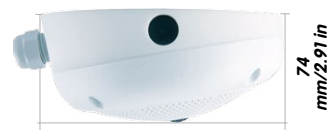

ø 166 mm / 6.54 in

## Notes

Use the fold-out template included at the end of the printed manual (valid for both 0° and 10° On-Wall Sets).

Make sure that the drilling template is not scaled or adjusted to the paper size when printing the PDF file (enlarged or reduced).

The maximum torque for all screws is 1 to 1.2 Nm.



In-Ceiling Set



The In-Ceiling Set must be ordered separately from the MOBOTIX camera.

| Item | Quantity | Part Name  |
|------|----------|--|
| 3.1  | 1        | Ceiling mounting ring incl. 4 flat headed screws |
| 3.2  | 1        | Decoration ring                                  |
| 3.3  | 2        | Wrench for In-Ceiling mount                      |
| 3.4  | 4        | Clamps   |

## Drilling Template In-Ceiling Set

Find the drilling templates (scale 1:1) at the end of the manual as a fold-out

The In-Ceiling Set can be used in panels ranging from 6 to 22 mm/0.24 to 0.86 in thickness

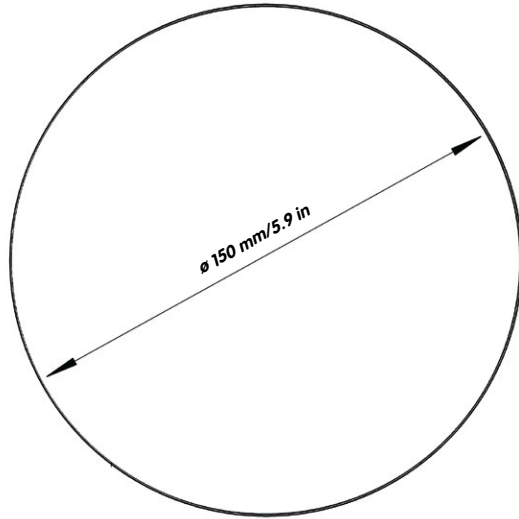
**Notes**

Find the folded drilling template at the end of the manual.

Make sure that the drilling template is not scaled or adjusted to the paper size when printing the PDF file (enlarged or reduced).

Vandalism Set



The Vandalism Set must be ordered separately from the camera.

| Item | Quantity | Part Name                                  |
|------|----------|--|
| 4.1  | 1        | Stainless steel cover 2 mm stainless steel |
| 4.2  | 4        | Spacers for Vandalism set                  |
| 4.3  | 4        | Security screws M4x16 mm                   |
| 4.4  | 1        | Two-hole driver bit for security screws    |
| 4.5  | 1        | Polycarbonate dome incl. washer            |
| 4.6  | 1        | Lens wrench                                |

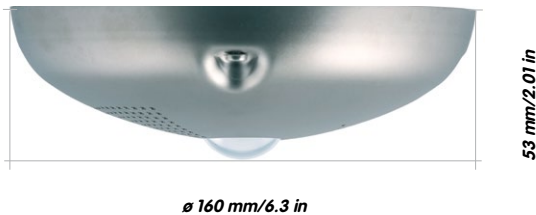

Available Variants of Vandalism Set:



*Stainless steel, polished*



*Stainless steel, matt*

Wall Mount

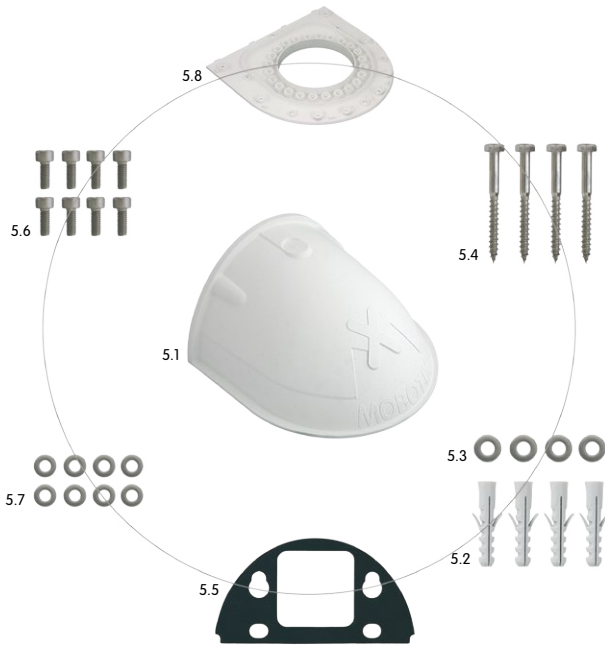

| Item | Quantity | Part Name   |
|------|----------|---|
| 5.1  | 1        | Wall Mount  |
| 5.2  | 4        | Universal screw anchors 8 mm                      |
| 5.3  | 4        | Stainless steel washers Ø 6.4 mm                  |
| 5.4  | 4        | Stainless steel wood screws with hex head 6x50 mm |
| 5.5  | 1        | Wall sealing                                      |
| 5.6  | 8        | Stainless steel Allen screws M4x16 mm             |
| 5.7  | 8        | Stainless steel washers Ø 4.3 mm                  |
| 5.8  | 1        | Bottom plate                                      |

## Drilling Template Wall Mount

Find the drilling templates (scale 1:1) at the end of the manual as a fold-out

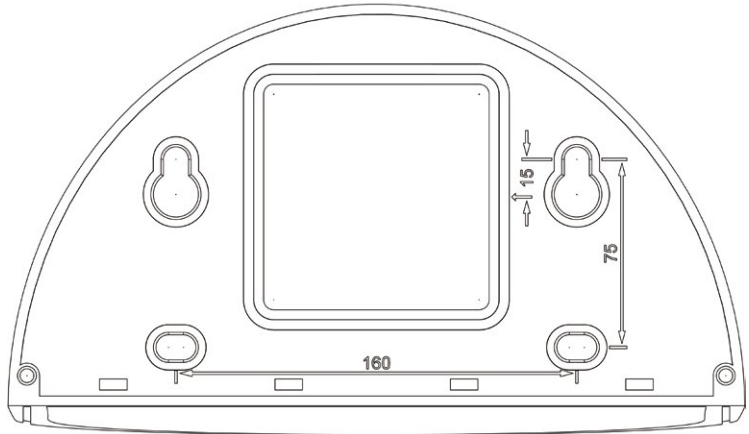

Direct installation over on-wall and flush-mounted wall outlets



**Depth: 201 mm/7.91 in**



**Width: 216 mm/8.5 in**

**Notes**

Find the folded drilling template at the end of the manual.

Make sure that the drilling template is not scaled or adjusted to the paper size when printing the PDF file (enlarged or reduced).

Corner And Pole Mount

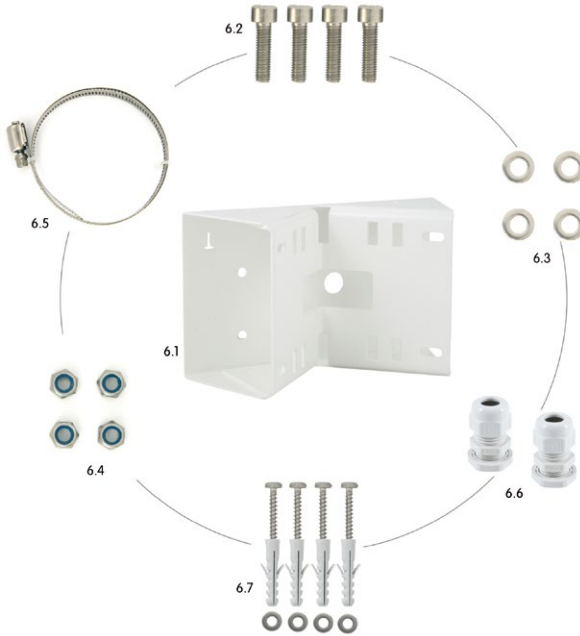

| Item | Quantity | Part Name  |
|------|----------|--|
| 6.1  | 1        | Pole mount, stainless steel, white, powder-coated  |
| 6.2  | 4        | Stainless steel Allen screws M6x20 mm              |
| 6.3  | 4        | Stainless steel washers Ø 6 mm                     |
| 6.4  | 4        | Stainless steel lock nuts M6                       |
| 6.5  | 2        | Stainless steel straps                             |
| 6.6  | 2        | Cable fitting with counter nut and O-ring cord     |
| 6.7  | 4        | Wood screws 6x80mm incl. screw anchors and washers |

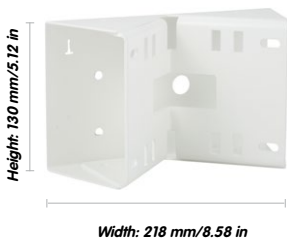

## 1.4 Available Accessories

### 1.4.1 On-Wall Set

Order no.: MX-OPT-AP

Consists of On-Wall Mount and mounting supplies. Conforms to U.S. installation standards. Reliably protects the cabling and allows integrating additional modules within the On-Wall Mount (WLAN, battery, ...).



### 1.4.2 10° On-Wall Set

Order no.: MX-OPT-AP-10DEG

Consists of On-Wall mount and mounting supplies for inclined installation (10°) of a camera. Conforms to U.S. installation standards. Reliably protects the cabling and allows integrating additional modules within the On-Wall Mount (WLAN, battery, ...).



### 1.4.3 Vandalism Set

Order no.: MX-Q25-Sec-Vandal-ESPO

Consists of polished stainless steel housing 1.5 mm strong, lens protector and security screws. Ideally suited for surveillance at critical locations.



Order no.: MX-Q25-Sec-Vandal-ESMA

Alternative design featuring matt stainless steel housing 1.5 mm strong. As above incl. lens protector and security screws.





#### 1.4.4 In-Ceiling Set

Order no.: MX-OPT-IC

For simple installation in false ceiling tiles. Suitable for discreet surveillance. Optionally available with a stainless steel ring.



Can also be used as a wall mount in drywalls

#### 1.4.5 Outdoor Wall Mount

Order no.: MX-OPT-WH

Consists of Outdoor Wall Mount and mounting supplies. Covers RJ45 wall outlets. Space for expansion modules (battery, UMTS, WLAN, etc.) Easily mounted to poles using Pole Mount. Weatherproof IP65.



#### 1.4.6 Corner and Pole Mount

Order no.: MX-OPT-MH

Flange for Outdoor Wall Mount. Can be mounted to wall corners or poles. 3 mm stainless steel, white. Wall Mount may be ordered separately or as a set.



#### 1.4.7 Stand/Wall Mount for Camera Tests

Order no.: MX-OPT-TW-Demo-1



The Stand/Wall Mount is a useful accessory for testing and for finding the optimum mounting position of the camera. The set also includes an Allen wrench as well as a Torx screw with dowel and the corresponding Torx wrench for installing as alternative wall mount for testing.

**Using as a Stand (with/without tripod)**

Using this stand, you can now place the camera upright on a flat surface or mount the whole assembly on a tripod (1/4" tripod thread at the bottom of the stand).



Only cables with angled plugs can be used for the Q25M

**1.4.8 MiniUSB Cable to MiniUSB (Angled/Straight)**

Order no.: MX-CBL-MU-EN-STR-05/2/5 (angled/straight)

MOBOTIX add-on modules (MX-232-IO-Box, ExtIO, CamIO) can be connected directly to the Q25M with this cable, which is up to five meters long.

**1.4.9 MiniUSB Cable to MiniUSB (Angled/Angled)**

Order no.: MX-CBL-MU-EN-EN-PG-05/2/5 (angled/angled)

The MOBOTIX ExtIO can be connected directly to the Q25M with this cable, which is up to five meters long.

**1.4.10 MiniUSB Cable to USB-A Socket**

Order no.: MX-CBL-MU-EN-AB-05/2/5

USB-based storage media (for example, USB hard drives) can be connected directly to the Q25M with this cable, which is up to five meters long.

**1.4.11 Ethernet Patch Cable for Bayonet Catch**

Order no.: MX-OPT-CBL-LAN-1/2/5/10 (length: 1 m/2 m/5 m/10 m)

The MOBOTIX-developed special cable can be installed in a waterproof manner and has an integrated sealing gasket. Every Q25M ships with a 0.5-m-long cable as standard, which can be exchanged for a patch cable up to 10 m in length.



## Available Accessories

### 1.4.12 NPA-PoE-Set

Order no.: MX-NPA-PoE-EU and MX-NPA-PoE-INT (Version EU and Version INT)

Order no.: MX-CBL-NPA-BAT-2 (battery cable for mobile voltage sources)

This is a multifunctional PoE injector according to the IEEE 802.3af standard – with three connectors (for network, camera/PoE device, PC), universal power supply unit with interchangeable adapter plugs and crossover function. The NPA-PoE-Set connects and remotely supplies a Q25M with power via an Ethernet cable up to 100 m in length. The blue adapter can also be connected to mobile voltage sources from 12 to 57 V DC by means of an additionally available battery cable. The “EU” version of the NPA-PoE-Set is supplied as standard with a European adapter, while the “INT” version includes four adapters (EU, USA, UK, AUS).



### 1.4.13 MX-Overvoltage-Protection-Box

Order no.: MX-Overvoltage-Protection-Box-RJ45

Order no.: MX-Overvoltage-Protection-Box-LSA

Weatherproof network connector (protection class IP65, –30 to +60°C/–22 to +140°F) **with surge protection of up to 4 kV for MOBOTIX IP cameras**, ideal for replacing the MX-Patch-Box.

At the same time, the MX-Overvoltage-Protection-Box provides a weatherproof connection of a camera's patch cable to a network patch cable (–RJ45 variant) or a network installation cable (–LSA variant).



### 1.4.14 MX-NPA-Box

Order no.: MX-OPT-NPA1-EXT

The MX-NPA-Box is a weatherproof PoE injector conforming to the IEEE 802.3af standard and is designed to connect external voltage sources (12 to 57 V DC) to a MOBOTIX camera.

The MX-NPA-Box is equipped with the Patch-Box's weatherproof and extremely compact exterior housing (protection class IP65, –30 to +60°C/–22 to +140°F), which means it can also be installed in the space of the Outdoor Wall Mount. Interfaces of the MX-NPA-Box: Camera via patch cable, Ethernet via LSA+ and external power supply via terminal connector (12 to 57 V DC possible).



### 1.4.15 MX-GPS-Box

Order no.: MX-OPT-GPS1-EXT

The MX-GPS-Box primarily serves as a high-precision time source for systems without an Internet connection. In addition, it can provide triggering based on GPS events (reaching or moving away from a specified position; exceeding or not reaching a specified speed). This interface box can be attached to all MOBOTIX cameras with an MxBus interface.



The MX-GPS-Box is equipped with the same compact housing as the other interface boxes (protection class IP65,  $-30$  to  $+60^{\circ}\text{C}/-22$  to  $+140^{\circ}\text{F}$ ). This interface box should not be installed inside of other wall mounts, but on the exterior of the building with a large section of open sky above it. This ensures the best possible reception from GPS satellites and thereby the highest possible accuracy of the received GPS data. The maximum length of the MxBus wiring (0.8 mm diameter wires) is 50 m/55 yd.

### 1.4.16 MX-232-IO-Box

Order no.: MX-OPT-RS1-EXT

This box provides the signal inputs and outputs as well as the RS232 (serial) interface. It replaces the connections that were handled on the older camera models via a D-Sub 15-HD connector. The MX-232-IO-Box (protection class IP65,  $-30$  to  $+60^{\circ}\text{C}/-22$  to  $+140^{\circ}\text{F}$ ) can be attached to all MOBOTIX cameras with an MxBus or USB interface. The maximum length of the MxBus wiring (0.8 mm diameter wires) is 50 m/55 yd. If the MiniUSB connector is used, the maximum cable length is 5 m/16 ft.



### 1.4.17 ExtIO Expansion Module

Order no.: MX-ExtIO

The device, which is suitable both for on-wall and in-wall installations, contains a powerful speaker, microphone, infrared motion sensor, ambient temperature sensor, two input and two output contacts and two illuminated keys. It is ideal for door communication, elevators, access control systems, etc. The ExtIO is suitable for use as direct connection to the S15 via a MiniUSB cable (max. 5 m), which can be ordered separately, or as a network connection via the PoE switch.



### 1.4.18 Mx2wire+ Media Converter

Order no.: MX-2wirePlus-Set-PW

The Mx2wire+ system allows an Ethernet network with PoE to be set up via two-wire cables, which saves users from having to lay several hundred meters of Ethernet cable. For example, an existing two-wire cable of an analog video camera can be reused to connect a high-resolution and modern IP network camera. Mx2wire+ is delivered in the standard wall outlet frame in different designs; however, it can also be used with the available on-wall socket that is included.



### 1.4.19 Other Accessories

Since the range of accessories for the MOBOTIX system keeps growing, you should visit the MOBOTIX website [www.mobotix.com](http://www.mobotix.com) in the **Products > Accessories** section to see the entire list of available accessories.

## THE MOBOTIX INFORMATION CHANNELS



### Support on the MOBOTIX Website

[www.mobotix.com/other/Support](http://www.mobotix.com/other/Support)



### The MOBOTIX Video Tutorials

[www.mobotix.com/other/Support/Tutorials](http://www.mobotix.com/other/Support/Tutorials)



### Seminars on MOBOTIX Campus

[www.mobotix.com/other/Partners/Seminars](http://www.mobotix.com/other/Partners/Seminars)



### The MOBOTIX YouTube Channel

[www.youtube.com/MOBOTIXAG](http://www.youtube.com/MOBOTIXAG)

## 1.5 MOBOTIX Software

### 1.5.1 Integrated Camera Software (Firmware)

MOBOTIX cameras and connected MxBus modules operate with built-in firmware whose functions are accessed by the MOBOTIX **MxControlCenter**, **MxEasy** remote stations and **MOBOTIX App**.

The Q25M models therefore also feature a variety of functions that are integrated in the firmware: from motion detection and long-term storage right through to alarm notification via video IP telephony. The virtual PTZ functions allow you to continuously zoom into or out of a MOBOTIX camera image using either the mouse wheel or a joystick.

When recording image or video sequences, you can choose to store either the section of the live image that is visible or the full sensor image (full image storage). This also allows you to examine parts of an image or video that had not been visible in the live image section on display at the time of the recording.

Unlike in the camera systems from other manufacturers, there is no need to buy an install additional software on your computer thanks to the MOBOTIX firmware that can be accessed directly in a web browser via the camera IP address. Instead of using a web browser, you can also download the free MxControlCenter or MxEasy video management software from the MOBOTIX website ([www.mobotix.com](http://www.mobotix.com) > **Support**) to quickly display multiple cameras on one monitor or on an entire video wall, switch alarms with sound or conveniently search for an event. The **MOBOTIX App** for iOS devices (iPhone, iPad, iPod mini, iPod touch, iOS version 5.0 and higher) is also available free of charge from the **App Store** for your mobile applications.

Download free of charge  
from [www.mobotix.com](http://www.mobotix.com)

No license fees!  
Free updates!



1.5.2 MxControlCenter

The MxControlCenter video management software can be used to combine any number of cameras at any locations into a well-structured and powerful video security system with centralized or local access-protected operation and analysis.

The state-of-the-art software, specifically tailored to support high-resolution MOBOTIX network cameras, provides a user-friendly user interface and camera image display, convenient video search functions, effective alarm handling, automatic camera integration, video storage on file servers as well as useful configuration and update wizards.

**MxControlCenter –Professional Video Management**

- Proven worldwide in the most demanding video applications thousands of times over
- Unlimited number of users and cameras
- No license fees
- Individual user interface, adaptable to each individual user
- Simplest installation and complete use on any standard PC
- Convenient layout editor for integrating real building plans
- Integration of conventional network and analog cameras as well
- For Microsoft Windows



Several hundred cameras can be managed on a standard computer

Download free of charge from [www.mobotix.com](http://www.mobotix.com)

No license fees  
Free updates



### 1.5.3 MxEasy

MxEasy makes it simple to operate the most important functions of the camera thanks to its intuitive user interface and represents a new approach to viewing and controlling MOBOTIX cameras. The clear design allows you to manage up to 16 cameras, and the application can show up to four cameras at the same time.

All settings selected in MxEasy (for example, virtual camera position, zoom, brightness, volume, microphone sensitivity, image storage, signal outputs) can be used immediately and are stored instantly in the configuration of the corresponding camera. The calendar functions integrated in the Alarm Planner provide an innovative tool for the scheduled settings of one or more cameras. This tool not only controls video and sound recording based on certain time and date information, but also allows features like video motion detection, image brightness and the microphone to be activated/deactivated based on a date and time schedule.

#### MxEasy – Simple Operation of the Most Important Camera Functions

- Cameras can be installed without any knowledge of networks
- Supports up to 16 MOBOTIX cameras
- Time- or event-controlled recording
- Time-controlled motion detection, image brightness and microphone
- For Microsoft Windows and Mac OS X

Suitable for up to 16  
MOBOTIX cameras

Download free of charge  
from [www.mobotix.com](http://www.mobotix.com)

No license fees  
Free updates





1.5.4 MOBOTIX App

**Premium solution:** There for you whenever and wherever you need it, the MOBOTIX App serves as the perfect remote mobile station that uses intelligent detailed solutions to increase security and convenience for users on a daily basis. The controls are optimized for use with touchscreen devices and feature three main views (Live, Player, Events), self-explanatory symbols, large software buttons, multifunctional sliders developed by MOBOTIX as well as simple gestures like swipe and tap, making it easy for newcomers and older users to work with professional security equipment. In addition, using mobile devices to operate the various functions such as door opening, activating the voice mailbox, switching the door bell off at night and switching a light on/off, creates added value in the form of greater convenience and security in every day life.

**MOBOTIX App – Mobile Remote Station for MOBOTIX Cameras and Door Stations**

- Bandwidth-optimized remote access via WLAN (WiFi) or the Internet
- Live images and recordings in the best MOBOTIX HiRes quality
- Two-way communication, door opening and video mailbox access
- Doorbell and alarm notifications, protection of privacy
- Convenient search functions, playback of external MxPEG videos
- Grouping of cameras and filtering of events
- Free from the **App Store** for the iPad, iPad mini, iPhone and iPod touch



Free download from the App Store

No license fees  
Free updates

## 2 INSTALLATION

The Q25M is primarily designed for installation on walls or ceilings. The supplied L12 180° lens captures the entire room, practically from wall to wall and from floor to the ceiling. See *Section 2.2, «Mounting the Camera Without Accessories»* and the following sections for information on the different installation options; the drilling templates can be found at the end of the manual.

### 2.1 Preparing the Installation

Before mounting the MOBOTIX Q25M, the following questions should be answered:

1. **Where will the camera be mounted?**

Mounting to a ceiling or wall; see *Section 2.1.1* and *Section 2.1.2*

2. **Which other mounting options are available?**

On-wall mounting, in-ceiling mounting, vandalism protection, wall mounting, pole mounting, see *Section 2.1.3*

3. **How is the camera connected to network and how is power supplied?**

MX-NPA-PoE or other PoE components (IEEE 802.3af), see *Section 2.1.4*

4. **How are the connections furnished from the building?**

Wall outlets, see *Section 2.1.5*

5. **What cabling considerations are necessary?**

Wiring, see *Section 2.1.6* and *Section 2.9*

The following sections contain a brief answer to each of these questions, as well as references to the relevant sections in this manual. For more information on the MOBOTIX Q25M and available accessories, please see [www.mobotix.com](http://www.mobotix.com).

Wall installation with  
On-Wall Set 10°



## 2.1.1 Wall-Mounted

To make optimal use of the high-resolution 180° panorama functionality of the Q25M, the camera must be mounted on an internal or external wall. The entire hemisphere of the room directly in front of the camera is then effectively monitored, from the wall on the left of the camera to the wall on the right. Corresponding fine-tuning in the user interface software allows the displayed panorama image to be adjusted to different practical applications (see *Section 3.3*).



Wall installation with On-Wall Set 10°

The camera should preferably be mounted in the middle of the room to be monitored using the 10° On-Wall Set

The Q25M Panorama: one camera - three simultaneous views

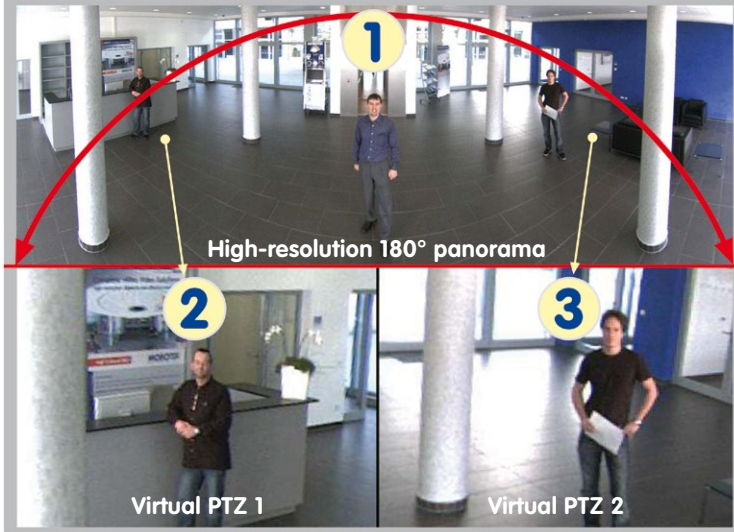

Original image from the camera shown above using the 10° On-Wall Set (Panorama Focus View)

### Selecting an Appropriate Camera Position

The Q25M is primarily suited to providing an excellent overview, and less suitable for more exact details. For active operation, the camera should be mounted at a (out of direct reach) height ranging from 2.5 to 3.5 m. People, for example, may be identified very well at distances of up to 1.5 m, and with sufficient detail at up to 3 m. Objects can be recognized even at distances of 5 m and more from the camera. During installation, ensure that the camera is focused on the most important areas of the room as directly as possible, in order to provide the desired level of detail recognition. For wall installation, use of the 10° On-Wall Set is ideal in many cases.

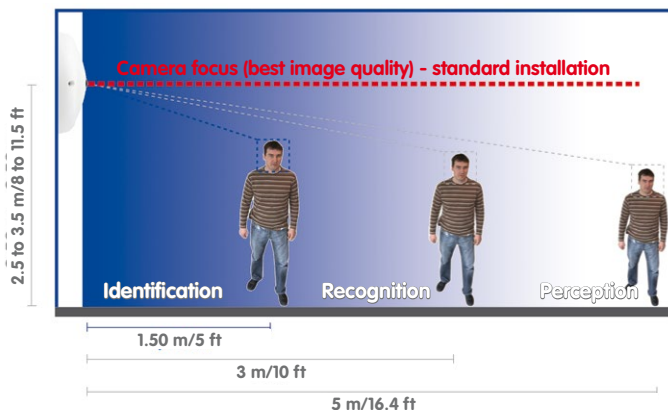

Wall Mount: Mounting the camera at the center of the wall



The OBEN / TOP label is only visible when the outer shell is removed

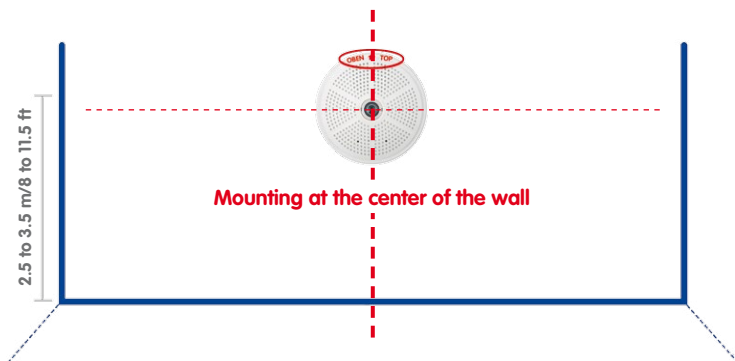

**Hint:** The Q25M should always be installed on a wall such that the arrow on the camera housing marked OBEN / TOP points towards the ceiling of the room.

### Wall Installation with the 10° On-Wall Set for Image Optimization

An on-wall set, available as an accessory in 0° and 10° inclinations, may also be used for installation. While the 0° set primarily offers easier installation and more storage space for cables and add-on modules (WLAN, connectors, etc.), the 10° set may also increase the image quality in certain cases. In particular for wall installations which must be carried out at greater heights for technical or other reasons (over doors, windows, etc.) adding a slight tilt to the camera, and thus also the lens, will return better results, as the center of the lens is then focused more directly on the center of activity in the room (optimal utilization of lens capabilities).



Optimized image quality through wall installation with On-Wall Set 10°

### Wall Mounting Over a Wall Outlet

Professional wall or ceiling installation of a Q25M is generally possible without accessories. However, due to elevation of the rear casing of the camera caused by connections and holders, a wall outlet should be installed prior to camera installation (see drilling template Q25M). This provides perfect protection to the cabling, ensuring that it cannot be seen or damaged from outside.

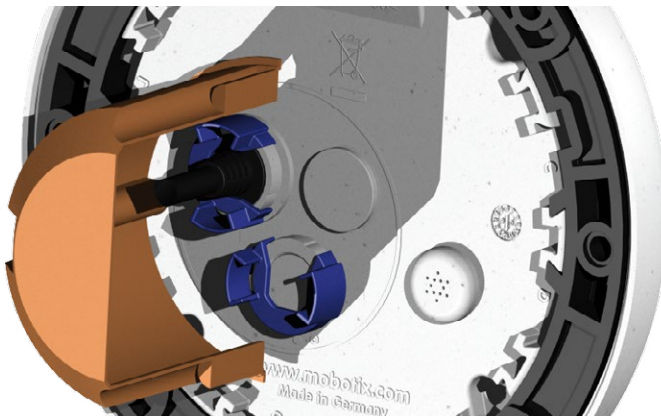

Discreet ceiling  
installation using the  
In-Ceiling Set

### 2.1.2 Ceiling-Mounted



Thanks to its hemispherical lens, a single Q25M can monitor an entire room right into each of the four corners (360° Panorama View). The camera should ideally be positioned on the ceiling in the center of the room. Due to its inherent physical and optical properties, the precision of the lens decreases as the distance from the lens grows. This means that the maximum usable image area varies greatly depending on the intended purpose of the camera. Rooms with a square floor area of up to approx. 40 m<sup>2</sup> in general allow recognizing details even at the borders of the full image. If you would only like to know if persons enter a room, or to monitor specific objects, rooms of up to 100 m<sup>2</sup> floor area can be monitored using a single Q25M.

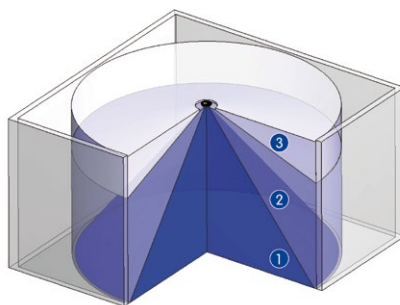

The **image quality** (precision) diminishes as the distance of an object to the camera focus point increases: 1 very good, 2 good, 3 satisfactory

Outdoors, the Q25M is usually mounted on a building wall, corner or pole instead of the ceiling. **For this situation, we recommend the use of the practical wall mount from the range of accessory products (see Section 2.6) or an extension.**

## Non-Square Rooms

When viewing a 360° (full) image in the browser, you will notice that the top and bottom of the image is not fully visible, i.e. some image information has been clipped. This is not a fault of the camera, but intended behavior that aims at achieving the best possible utilization of the image sensor by the camera software. Bearing this in mind, it is advisable to install the Q25M in rectangular room ceilings so that the arrow marked OBEN / TOP points towards one of the longer walls of the room as shown in the figure.

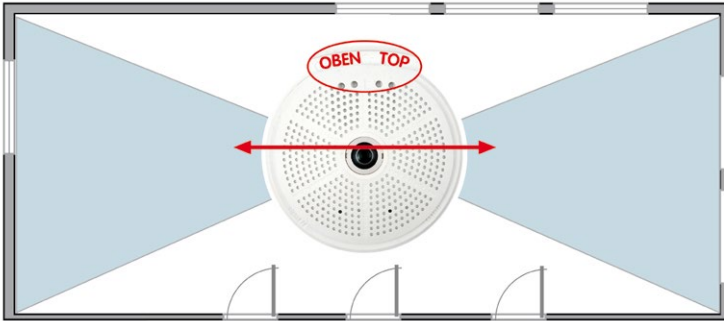

Original full image from the Q25M (ceiling installation in a rectangular room)

Never mount the camera to metal surfaces (condensation may damage the camera):  
**MOBOTIX recommends using an On-Wall Mount or the Wall Mount**

### Lowered Mounting or Mounting on Extensions

When mounting the camera in rooms with a high ceiling, or outdoors, it may be advisable to mount the camera in a lower position. This reduces the distance between the camera and the objects that are to be monitored, which in turn increases the recognizability of details. One practical solution would be to install the camera on a base plate attached to a suitable extension (metal tube) hanging from the ceiling. The network cable can be hidden from view by running through the interior of the tube.

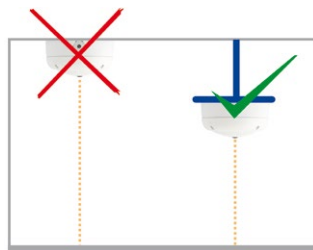

Similar to lowered mounting from the ceiling, you can also attach the camera to an extension mounted to a wall to better use the 360° image of the camera (e.g. outside, above a portal). Such an installation would use the pole mount accessory (MX-D22-OPT-MH) in conjunction with the wall mount (MX-D22-OPT-WH) as a sturdy base for the camera, which is then mounted to the extension pole.

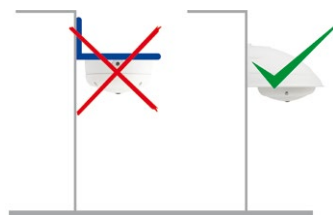

MOBOTIX does not recommend attaching the camera directly to metal carriers, especially when mounting the camera outdoors or when the ambient temperature varies greatly. As an additional measure to protect the camera against condensation, you should use either the On-Wall set (MX-D22-OPT-AP) or the Wall Mount (MX-D22-OPT-WH).

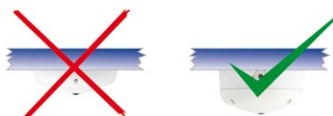

For the installation on building corners, the Corner and Pole Mount and a Wall Mount will be needed

### Installation on Building Corners with the Corner and Pole Mount

This is a special method of Q25M installation, offering substantial advantages for the outdoor surveillance of buildings.

The hemispherical lens of a single Q25M can cover the entire 270° range from one building wall to the other, for an "around the corner" view!

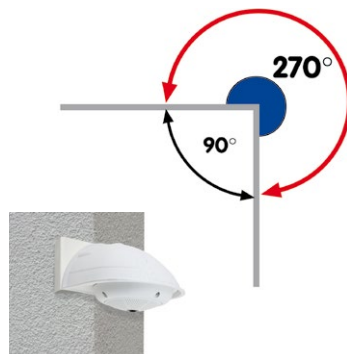



## Preparing the Installation

### 2.1.3 Mounting Options

#### On-Wall Installation (MX-OPT-AP)

The On-Wall Set can reliably protect external cables if the cables cannot be fed in the center below the camera housing. The On-Wall mount also provides ample space for extra modules.



On-Wall Set (IP65, for outdoor applications)

#### On-Wall Installation with 10° Inclination (MX-OPT-AP-10DEG)

This On-Wall Set is identical to the regular On-Wall Set, except that the mounted camera is tilted by 10 degrees. The inclination makes it possible for the camera to deliver the best images even in demanding situations.



On-Wall Set 10° (IP65, for outdoor applications)

#### In-Ceiling Installation (MX-OPT-IC)

The In-Ceiling Set allows the Q25M camera to be installed in suspended ceilings, for example. This type of installation provides optimum protection for the camera and reduces the visible profile to a minimum, since the camera only protrudes 24 mm from the ceiling.



Discreet in-ceiling installation; decorative outer ring also available in stainless steel

#### Vandalism Set (MX-Q25M-OPT-VANDAL)

The Vandalism Set provides added protection for Q25M cameras. The set consists of a robust stainless steel cover (matt or polished) and an impact-resistant polycarbonate dome. A camera equipped with the Vandalism Set is perfectly suited for applications in demanding environments (such as prisons, trouble areas, train stations, etc.).



Vandalism Set (IP65)

#### Wall Mount (MX-OPT-WH)

The Q25M/D25M Wall Mount is the ideal solution for mounting the to walls for indoor and outdoor applications. The camera is absolutely dustproof and resistant against water jets (IP65). The wall mount also covers RJ45 wall outlets and has ample space for additional modules.



Wall Mount made from sturdy PBT-30GF (IP65)

#### Corner and Pole Mount (MX-OPT-MH)

The MOBOTIX Corner and Pole Mount is the ideal choice when mounting the MOBOTIX Q25M to a pole or building corner (Panorama View covering approx 270°). This mount can only be used in conjunction with the wall mount. For poles with a diameter ranging from 60 to 180 mm.



Outdoor Corner and Pole Mount made from stainless steel (in conjunction with Wall Mount)

**Stand/Wall Mount for Camera Tests (MX-OPT-TW-Demo-1)**

The Stand/Wall Mount is a useful accessory for testing and for finding the optimum mounting position of the camera. The set also includes an Allen wrench as well as a Torx screw with dowel and the corresponding Torx wrench for installing as alternative wall mount for testing.

**Using as a Stand (with/without tripod)**

Using this stand, you can now place the camera upright on a flat surface or mount the whole assembly on a tripod (1/4" tripod thread at the bottom of the stand).

**Converting to a wall mount (simulation of On-Wall set with 10 deg. tilt)**

1. If required, release the two stainless steel Allen screws and remove the camera from the stand/wall mount.

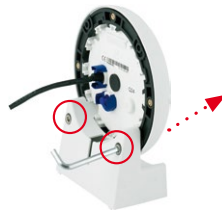

2. Place the camera with the two upper body screws exactly into the two receptacles of the Stand/Wall Mount. **Note:** The print on the camera back is legible.

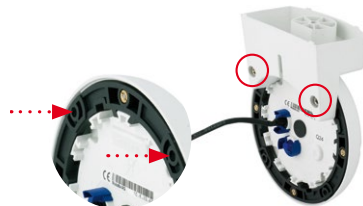

Installation hint: The print on the camera back is legible.

3. Mount the camera to the stand using the two stainless steel Allen screws.



4. Use the Torx screw to fasten the mount onto the wall. Make sure that the head of the screw is not tight against the wall, but that it still has 5 mm/0.2 in to go.

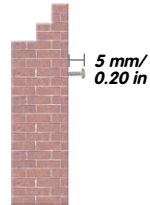

5. Slide the entire assembly from above over the Torx screw in the wall.

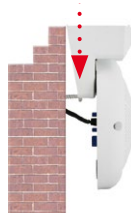

6. Properly tighten the Torx screw to secure the assembly in the desired position. There is a special hole in the Stand/Wall Mount to access the Torx screw.



### Caution

The Stand/Wall Mount has been only designed used for testing purposes. Make sure that you replace this mount by a proper wall mount before bringing the system into service.

The Q25M supports the Power over Ethernet standard IEEE 802.3af (PoE)

The Network Power Adapter replaces the crossover cable when directly connecting to a computer



## 2.1.4 Network Connection And Power Supply, UPS

### Power Over Ethernet (PoE Conforming to IEEE 802.3af)

All Q25M models are supplied with power using the PoE standard. The Network Power Adapter (MX-NPA-PoE-Set) may be used for smaller installations. For larger installations, it is worth investing in a PoE capable supply device available on the market.



The **maximum length** of the network cable for power supply over an Ethernet cable is **100 m**. The Mx2wire+ media converter set (available as an accessory) can be used to extend the range of an Ethernet connection up to 500 m in length (maximum transmission speed for a 500-m cable: 45 Mbps and 12 W for the PoE device).

#### Note

The MOBOTIX Q25M can be powered by switches or routers which support the PoE (Power-over-Ethernet) standard and conform to IEEE 802.3af.

#### Advantages of PoE power supply:

- Allows setting up centralized backup power supply via the network.
- Reduces energy consumption.
- No extra network connection for camera required.

### Using Uninterruptible Power Supplies (UPS)

You should install an uninterruptible power supply (UPS) in order to maintain a continuous power supply even when utility power fails. These devices also provide full protection against electrical surges and voltage fluctuations, enhancing the reliability of the system as a whole.

When using a more powerful 19" rack-mounted UPS, you can also protect all other network components (for example, switches, routers, PoE switches, etc.).

Since MOBOTIX cameras do not require any heating, even during winter, the average power consumption of approx. 3.5 watts is very low. This, in turn, means that you can centralize the UPS-protected power supply by injecting power into the Ethernet cables (max. 100 m). This kind of protected power supply can be used either with MOBOTIX PoE products (MX-NPA-PoE + Universal Power Supply) or with PoE-compliant switches according to IEEE 802.3af.



### 2.1.5 Preparing the Camera Connections, MX-Overvoltage-Protection-Box

Once the camera position, the position of the cable outlets and the method of power supply have been decided upon, the cabling can be installed. Before installing the MOBOTIX Q25M, you should make sure that the network connections have been properly tested so that the proper functioning of the camera is guaranteed.

If the camera is to be installed outdoors, you should also install the MOBOTIX MX-Overvoltage-Protection-Box (optional accessory). This interface box not only provides **overvoltage protection of up to 4 kV for MOBOTIX IP cameras**, it also provides simple and weatherproof connection of the cameras to a network patch cable (-RJ45 variant) or a network installation cable (-LSA variant).

For additional information on the MX-Overvoltage-Protection-Box, open the **Products > Accessories > Interface Boxes** section on [www.mobotix.com](http://www.mobotix.com).

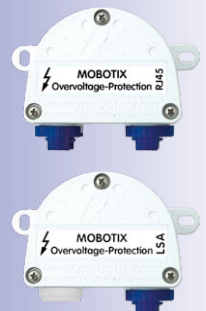

UPS units not only protect the camera against power failures, they also protect all other connected network devices against damage from voltage peaks and lows

### 2.1.6 Wiring, Fire Prevention, Lightning and Surge Protection

When installing the wiring inside or outside of buildings, make sure you always adhere to the relevant regulations on wiring, fire prevention and protection against lightning.

MOBOTIX cameras are protected against the effects of small electrical surges by a range of measures. These measures, however, cannot prevent the camera from being damaged when stronger electrical surges occur. Particular care should be taken when installing the camera outside to ensure proper **protection against lightning**, as this also protects the building and the entire network infrastructure.

MOBOTIX recommends having MOBOTIX cameras installed only by certified specialists accustomed to installing network devices and having proper respect for the applicable regulations regarding lightning protection and fire prevention as well as the current technology for preventing damages from electrical surges.

#### Guidelines for Wiring

- **Data cable:** Make sure you only use double-shielded CAT5 or higher cable (**S/STP**) for Ethernet connections.
- **Outdoors:** Installing the camera outdoors requires special precautions and measures regarding the cables as well as lightning and surge protection (see below).
- **Wire lengths:** The cable segments must not exceed the maximum allowed cable lengths in order to ensure proper data transfer (see *Section 2.9*).
- **Avoiding induction:** When running data cables parallel to existing regular power lines or high-voltage wires, make sure you observe the minimum distances to the power cables.

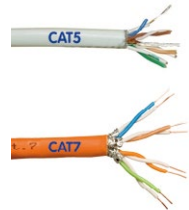

#### Fire Prevention

When installing the power lines to the camera, make sure you always adhere to the country-specific regulations (e.g. VDE in Germany, IEEE in the USA) in effect on wiring and fire prevention at the site of the installation.

### Lightning and Surge Protection

In order to avoid damage to MOBOTIX cameras from overvoltages, you should always install the **MX-Overvoltage-Protection-Box**. This competitively priced and weatherproof network connector provides reliable protection against overvoltages of up to 4 kV; the box is easily installed in the Outdoor Wall Mount, for example (see *Section 1.4.13, «MX-Overvoltage-Protection-Box»*).

More information is available at an institution such as the International Electrotechnical Commission (IEC, [www.iec.ch](http://www.iec.ch)) or at a manufacturer of protection devices against lightning and electrical surges, such as Dehn ([www.dehn.de](http://www.dehn.de)).

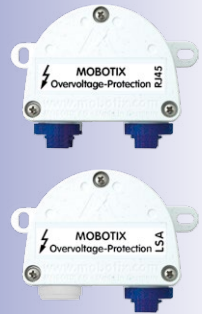

## 2.2 Mounting the Camera Without Accessories

### 2.2.1 Mounting Instructions

The Q25M, being an overview camera, is primarily designed for installation on walls or ceilings. Direct installation of the camera without any accessories is, in general, always possible, however - due to elevation of the rear casing of the camera where connections and their holders are - a flush-mounted wall outlet should be installed first.

Installation over a standard flush-mounted wall outlet (minimum installation depth 20 mm/8 in)

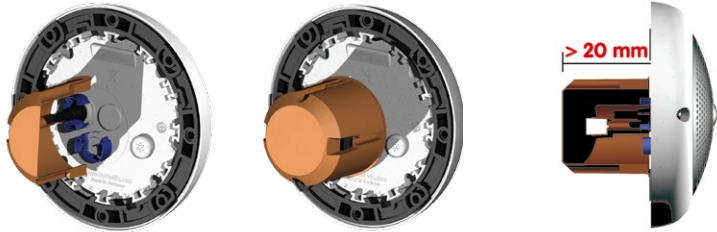

The drilling template also includes a blue circle marking the minimum size and position of this wall outlet, in addition to the drilling holes. To guarantee maximum coverage of the room by the camera, the Q25M should be positioned on the wall or ceiling as close to the middle of the room as possible.

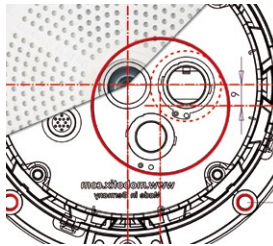



### Required Tools

Please check that all components supplied with the camera are present in the original packaging first (see *Section 1.3.7*). The following additional tools are required for installation:

- Any additional materials for fastening the camera to a ceiling/wall, if necessary – **4 wood screws incl. screw anchors and washers** are included in the original packaging.
- **Screwdriver**
- **Power drill** for screw anchor holes needed for ceiling/wall mounting
- **MOBOTIX Drilling Templates** (at the end of this manual)
- **Scissors** to cut out the template
- **Pen** to mark the drill holes
- Materials and any tools needed to connect the pre-installed MOBOTIX network cable in the camera with the on-site network cable.
- **Wall outlet and tools** to install the outlet in the wall/ceiling (keyhole saw)
- **Soft cotton cloth** to clean the front of the lens







Q25M seen from the side with cable bent properly

Due to the space required for cable and connectors, we recommend a flush-mounted wall outlet with an installation depth of at least 20 mm/8 in

RJ45 patch cable: 50 cm (19.7 in) cable incl., other lengths available from MOBOTIX as accessories

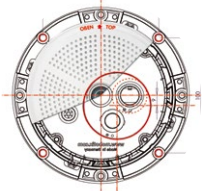
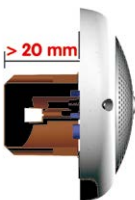
Due to the space required for cable and connectors, we recommend a flush-mounted wall outlet with an installation depth of at least 20 mm/8 in

### 2.2.2 Procedure

1. Install and prepare the **network connection**.
2. **Install the flush-mounted wall outlet:** The pre-installed cable attached to the camera must be connected with the on-site network cable. For installation without accessories, a flush-mounted wall outlet must be installed first, in order to provide a connection. The cabling is perfectly protected and cannot be seen or damaged. The camera cannot be mounted directly on top of protruding wall outlets. Use the supplied camera drilling template (fold-out at the end of this manual) to mark the position of the wall outlet for the desired camera position.
 

3. **Remove the outer shell:** Remove all four Allen screws using the supplied Allen wrench and lift off the outer shell.
 
4. **Drill the holes:** Drill the holes for the supplied screw anchors (see drilling template). Remember to take the proper direction of the camera into consideration (OBEN / TOP arrow pointing upwards for wall installation, or in the direction of the longer wall for ceiling installation in rectangular rooms).
 
5. **Connect the cable:** Connect the on-site network cable to the camera patch cable using a standard connector.
 

6. **Mount the camera:** Use the (included) screws to affix the mounting ring and the camera at the designated position.



7. **Install the rubber seal:** Place the rubber seal with the groove around the edge of the black mounting ring of the camera.



8. **Attach the outer shell:** Replace the outer shell and screw all four Allen screws tight using the supplied Allen wrench. Ensure that the rubber seal is properly positioned.



9. **Clean the lens:** If necessary, gently clean the front of the lens with a soft cotton cloth. Do not apply excessive pressure to the surface of the glass when cleaning the lens.
10. **Establish a connection to the camera, check the image:** Establish a connection to the camera as described in *Section 3.1* and the following sections. The live image from the camera should be visible on the computer monitor. Check image sections on the computer monitor as well.

### Caution

The **maximum torque** for all screws is **1 to 1.2 Nm**.

Only use the factory pre-installed network cable supplied with the MOBOTIX camera. Always ensure that the cable retainer with bayonet catch is closed properly around the network cable. All openings at the back of the camera housing except the pressure equalization element need to be sealed properly with the rubber plugs. This is the only way to guarantee that the camera remains weatherproof.

**Note****Note on fastening cables leading in to the camera:**

Cables passing in to the back of the camera (patch cable for the network connection and ExtIO cable) are secured using a special cable retainer with bayonet catch.

When replacing this cable, ensure that the cable is properly seated in the connector and that the retainer with the blue bayonet catch is locked (short clockwise turn until it clicks into place).

**Removing the Cable Retainer**

Rotate the bayonet catch anti-clockwise to the "open circle" symbol (see figure). The catch may be removed from the side. The cable can now be pulled out of the camera.



Open the cable retainer by rotating the bayonet catch to the marked position

Bayonet catch open



**Caution**

Only use **original MOBOTIX cables** to connect the camera. Standard cables purchased from other suppliers do not meet the necessary specifications for proper retention (no IP54 or IP65 weather protection).



*Ethernet patch cable*



*MiniUSB cable*

**Attaching the Cable Retainer**

Insert the cable into the receptacle on the camera. Position the bayonet catch from the side (opening points to the right). Rotate the bayonet catch clockwise to the "filled circle" symbol (see image). The cable is now properly retained.



Close the cable retainer by rotating the bayonet catch to the marked position

Bayonet catch closed



## 2.3 Mounting the Camera with the On-Wall Set



### 2.3.1 Mounting Instructions

On-Wall sets available in 0° and 10° inclinations allow fast and simple installation of the Q25M on a wall or room ceiling. When using the set outdoors (IP65), ensure that the screw holes on the rear of the camera housing are sealed with the included foam rubber washers.

It is not possible to install the on-wall set directly above an on-wall or flush-mounted outlet.

Installation using the 10° On-Wall Set is often the right choice if a Q25M is to be used as a panorama camera installed at a greater than usual height (3 m or higher). Tilting the lens in the direction of the center of activity in the room maximizes image quality. Consider the desired camera position carefully during installation!

If discreet appearance of the Q25M is of particular importance, the In-Ceiling Set for ceiling installation is the best possible choice (see *Section 2.6*).

The network connection and drill holes must be prepared correctly before installing the On-Wall Set (both indoors and outdoors):

- **Network connection:** You can use any one of the four openings in the On-Wall set to guide the cabling into the camera. The network cable must be fed through the opening without a connector. An additional connector to connect to the camera cable is required. When preparing for installation, keep in mind that the camera must later be positioned in the correct orientation, according to its purpose (OBEN / TOP arrow pointing upwards for wall installation, or in the direction of the longer wall for ceiling installation in rectangular rooms).
- **Preparing the drill holes:** Use the supplied drilling template for the Q25M On-Wall Set (fold-out at the end of this manual) to mark the position for drilling the anchor holes with regard to the camera position.

#### Caution

When using the On-Wall Set outdoors, ensure that the screw holes on the rear of the camera housing are sealed with the foam rubber washers included in delivery (IP65).

Drilling Template On-Wall Set

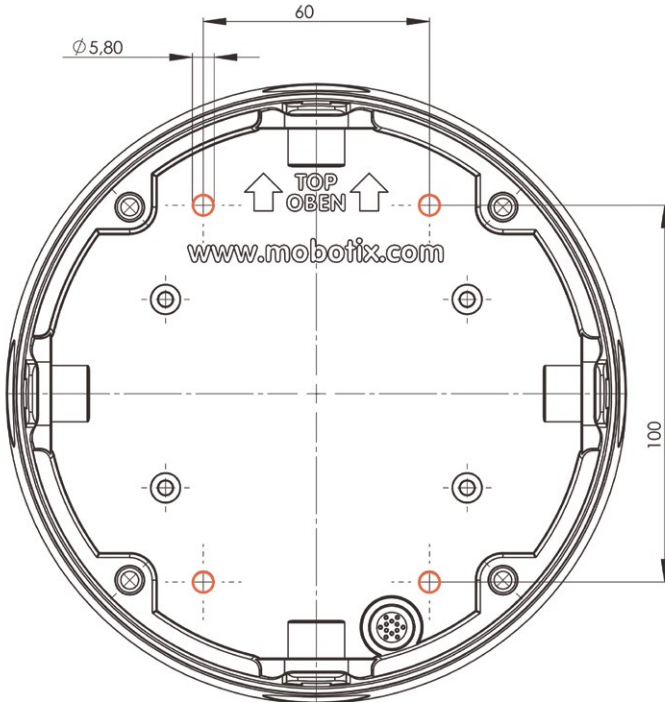

Find the drilling templates (scale 1:1) at the end of the manual as a fold-out

Notes

Use the fold-out template included at the end of the printed manual (valid for both 0° and 10° On-Wall Sets).

Make sure that the drilling template is not scaled or adjusted to the paper size when printing the PDF file (enlarged or reduced).

The maximum torque for all screws is 1 to 1.2 Nm.

### Required Parts

Please check that all components supplied with the On-Wall Set are present in the original packaging first. The following additional tools are required for installation:

- Suitable materials for ceiling/wall installation: **4 wood screws incl. screw anchors and washers** (e.g. from the original camera packaging).
- **Screwdriver**
- **Power drill** for screw anchor holes needed for ceiling/wall mounting
- **MOBOTIX Drilling Templates** (at the end of this manual)
- **Scissors** to cut out the template
- **Pen** to mark the drill holes
- Materials and tools needed to connect the pre-installed MOBOTIX network cable in the camera with the on-site network cable.
- **Soft cotton cloth** to clean the front of the lens





### 2.3.2 Procedure

1. **Attach washers:** Prior to installation, stick a black foam rubber washer around each of the four screw holes on the rear side of the on-wall housing (remove the adhesive foil and press into place, surface must be clean and free of grease). This prevents water from entering the housing.



2. **Prepare the cabling:** Insert the seal into the cable opening of the On-Wall Set such that the black rubber seal is on the outside. Fix it in place from the inside using a small hexagonal nut.



3. **Mount the On-Wall Set:** Mount the On-Wall Set (without the camera) at the intended position using e.g. the wood screws (included with Q25M camera, Pos. 1.13). Make sure the OBEN / TOP arrow points in the correct direction.



4. **Cable feeding:** Attach the counternut to the network cable, pass it through the seal from the outside and tighten the nut. The network cable is now screwed into the On-Wall Set, weatherproof. All unused openings must be sealed with the included sealant plugs. The cable passing into the housing must always be installed using the supplied three-part fittings.



5. **Remove the camera outer shell:** Unscrew all four Allen screws with the supplied Allen wrench. Remove the outer shell.



6. **Remove the mounting ring:** Separate the black mounting ring from the camera housing (lift the spring clip). This ring is not required when mounting the camera to the On-Wall set.



7. **Connect the cable:** Connect the on-site network cable to the network cable passing through the On-Wall Set using a standard connector. Excess cable can be stored easily within the On-Wall mount.



8. **Attach the camera to the mount:** The camera must be seated firmly within the On-Wall mount. The tapered guides at the back of the camera housing fit exactly into the openings of the On-Wall mount. Once, again, ensure that OBEN / TOP arrow points in the correct direction.



9. **Attach the outer shell:** Position the outer shell without the rubber seal and tighten all four Allen screws using the included Allen wrench.



10. **Clean the lens:** If necessary, gently clean the front of the lens with a soft cotton cloth. Do not apply excessive pressure to the surface of the glass when cleaning the lens.
11. **Establish a connection to the camera, check the image:** Establish a connection to the camera as described in *Section 3.1* and the following sections. The live image from the camera should be visible on the computer monitor. Check image sections on the computer monitor as well.

### 2.4 Mounting the Camera with the In-Ceiling Set



The decorative ring is available in different colors and in stainless steel

#### 2.4.1 Mounting Instructions

The In-Ceiling Set offers the most stylish installation option for the Q25M. When properly installed, the only visible component is a particularly sleek and discreet hemispheric camera, while most of the remaining components are concealed inside the ceiling.

For these reasons, the Q25M installed with the In-Ceiling Set is the preferred option for most indoor spaces frequented by customers or the general public (e.g. hotels, restaurants, banks, retail stores, public buildings, etc.).

The common use of suspended ceilings in commercial and public buildings is an additional reason to place a preference on in-ceiling installation. The installation process is also simplified, as the network cable may be laid without difficulty and only a 15 cm diameter hole must be cut in the ceiling or ceiling component.

Before installing the MOBOTIX Q25M to an indoor location using the In-Ceiling Set, you must prepare the network connection and drill a hole for the camera:

- **Network connection:** The network cable is fed through the ceiling directly above the camera.

When preparing for installation, keep in mind (particularly with regard to cable slack) that the camera may later need to be repositioned in the correct orientation, according to its specific purpose (OBEN / TOP arrow pointing in the direction of the longer wall for ceiling installation in rectangular rooms).

- **Cut a hole for installation:** The hole should have a **diameter of 150 mm** (see drilling template at the end of the manual).

See Section 2.4, «Mounting the Camera with the In-Ceiling Set» for a detailed description

## Drilling Template In-Ceiling Set

Find the drilling templates (scale 1:1) at the end of the manual as a fold-out

The In-Ceiling Set can be used in panels ranging from 6 to 22 mm/0.24 to 0.86 in thickness

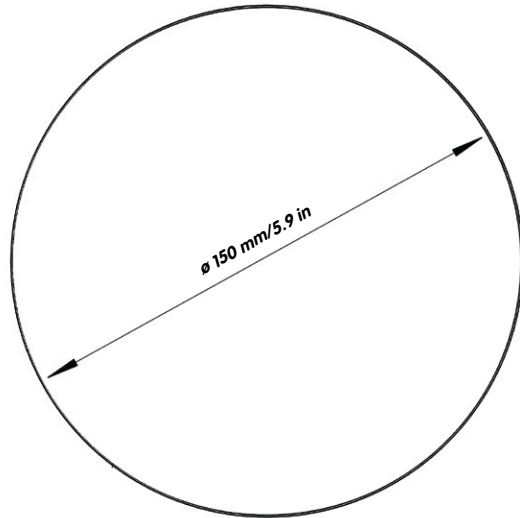
**Notes**

Find the folded drilling template at the end of the manual.

Make sure that the drilling template is not scaled or adjusted to the paper size when printing the PDF file (enlarged or reduced).

### Required Parts

Please check that all components supplied with the In-Ceiling Set are present in the original packaging first. The following additional tools are required for installation:

- **Power drill** with matching hole saw (150 mm diameter) or **jigsaw**
- **MOBOTIX Drilling Templates** (at the end of this manual)
- **Scissors** to cut out the template
- **Pen** to mark the hole positions
- **Two blue In-Ceiling wrenches** from the In-Ceiling Set
- Materials and tools needed to connect the pre-installed MOBOTIX network cable in the camera with the on-site network cable.
- **Soft cotton cloth** to clean the front of the lens



### 2.4.2 Procedure

1. **Prepare the network connection:** Run the network cable above the suspended ceiling and ensure that enough cable slack is available.
2. **Cut a hole for installation:** Cut a round hole for camera installation (e.g. with a 150 mm hole saw). Use the supplied cutting template of the In-Ceiling Set (fold-out at the end of the manual).

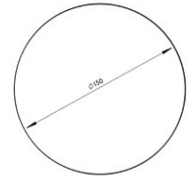

3. **Remove the outer shell:** Remove all four Allen screws using the supplied Allen wrench and lift off the outer shell.



4. **Remove the mounting ring:** Separate the mounting ring from the camera housing. This ring is not required when mounting the camera in the In-Ceiling Set.

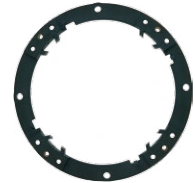

5. **Place the camera in the In-Ceiling Set:** The dovetail guides at the back of the camera housing fit exactly into the openings of the In-Ceiling mounting ring.



6. **Connect the cable:** Connect the on-site network cable to the camera network cable using a standard connector.

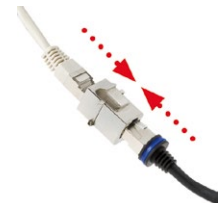

- 7. Insert the camera and the In-Ceiling Set into the hole:** Make sure that all winged cams are retracted before placing the In-Ceiling Set with the camera into the hole. Pay attention to the orientation: the OBEN / TOP arrow should point in the direction of the longer wall for ceiling installation in rectangular rooms. Tightening the screws of the In-Ceiling Set extends the winged cams, thus firmly holding the set in place.

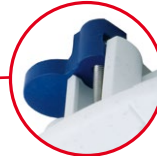

The blue winged cams (see left) automatically secure the In-Ceiling Set in the ceiling when tightening the screws

- 8. Install the decorative ring:** Use the two wrenches from the In-Ceiling Set to place the ring on the set as shown in the figure and turn the ring clockwise until it stops.



Installing the decorative ring: turn clockwise

The two **wrenches from the In-Ceiling Set** may also be used for **dismounting**. Insert them as shown and turn the ring counter-clockwise. Loosen the screws of the In-Ceiling Set; this will automatically retract the winged cams. You can now remove the In-Ceiling Set, with the camera still attached, from the ceiling.



Removing the decorative ring: turn counter-clockwise - only relevant when completely removing the camera

- 9. Clean the lens:** If necessary, gently clean the front of the lens with a soft cotton cloth. Do not apply excessive pressure to the surface of the glass when cleaning the lens.
- 10. Establish a connection to the camera, check the image:** Establish a connection to the camera as described in *Section 3.1* and the following sections. The live image from the camera should be visible on the computer monitor. Check image sections on the computer monitor as well.

## 2.5 Installing the Vandalism Set



### 2.5.1 Mounting Instructions

The Vandalism Set serves to provide additional security and protection for Q25M cameras. It may be installed with little effort and at low cost. This set is recommended for use under particularly demanding conditions (such as prisons, trouble areas, train stations, etc.). The set consists of a robust stainless steel cover for the camera housing (matt or polished) and an impact-resistant dome cover made of reinforced plastic.

To install the Vandalism Set, simply mount the stainless steel cover and the included security screws (with the four mounted spacers) over the standard housing.

#### Scope of Delivery and Required Parts

Please check that all components supplied with the Vandalism Set are present in the original packaging first. The following additional tools are required for installation:

- **Allen wrench** for removing the standard outer shell (included in Q25M packaging)
- **Screwdriver with bit receptacle** for the two-hole driver bit
- Clean and soft **cotton cloth**





### 2.5.2 Procedure

In order to install the Vandalism Set, replace the white plastic outer shell of the Q25M, including the Allen screws, with the stainless steel cover, the security screws and the four spacers of the Vandalism set.

1. **Remove the outer shell:** Remove all four Allen screws using the supplied Allen wrench and lift off the outer shell.



2. **Remove the lens gasket:** Unscrew the lens using the lens wrench (included with the camera) and remove the lens gasket.



3. **Replace the lens:** Screw the lens back in using the lens wrench.



4. **Adjust the live image:** Establish a connection to the camera as described in *Section 3.1* and the following sections. The live image from the camera should be visible on the computer monitor. Select the highest available image resolution. Check image sections (image center and focus) on the computer monitor and adjust the lens with the lens wrench if necessary.
5. **Clean the lens:** If necessary, gently clean the front of the lens with a soft cotton cloth. Caution: Do not apply excessive pressure to the surface of the glass when cleaning the lens!

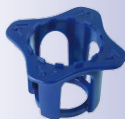

Lens wrench for installing the dome

Spacers for Vandalism set

Maximum torque for all screws is 1 to 1.2 Nm

Security screw and two-hole driver bit

Stainless steel cover must be positioned correctly to line up with the LED openings

6. **Mount the dome:** Screw the dome on in a clockwise direction using the supplied wrench. If required, clean the dome gently using a soft cotton cloth before completing installation. Check the sharpness of the camera image again, and correct it if necessary.



7. **Mount the spacers:** Place the **four spacers** on the mounting ring.

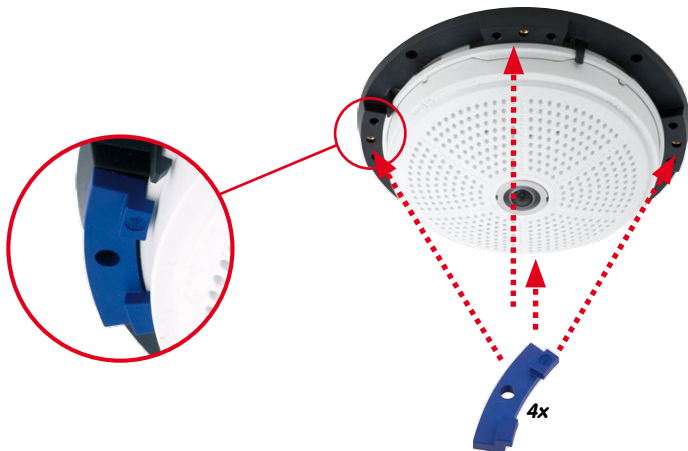

8. **Mount the stainless steel cover:** Position the stainless steel cover as shown and tighten the security screws using the included **two-hole driver bit**.



## 2.6 Installing the Wall Mount



### 2.6.1 Mounting Instructions

The Wall Mount allows you to easily mount Q25M cameras to walls or extensions, both indoors and outdoors. The camera remains IP65 weatherproof (dust-proof and resistant to water jets). The Wall Mount also covers RJ45 wall outlets and has ample space for additional modules (WLAN, batteries, etc.).

**Before mounting** the MOBOTIX Q25M with the Wall Mount, you must prepare the network connection and drill the holes for the fixtures:

- The **on-site network cabling** is passed through the opening in the back of the wall mount. The cable and the required (standard) connector for the camera cable (patch cable) are ideally protected by a robust wall sealing made from foam rubber. Nothing is visible or accessible from the outside. The Wall Mount may be mounted directly on top of flush or protruding wall outlets. Maximum width x height of the outlet: 88 mm x 80 mm.
- Only use the Q25M **factory installed patch cable** (50 cm cable length) or a MOBOTIX cable of different length available from the range of accessories.
- All openings of the camera housing need to be closed off properly. This is the only way to guarantee that the camera remains weatherproof.
- The included screw anchors should be used for the **drill holes** in the wall. Use the supplied drilling template for the Q25M Wall Mount (fold-out at the end of this manual) to mark the position for drilling the holes and the holes through which the cables will later be fed.



Direct installation over on-wall and flush-mounted wall outlets

## Drilling the Holes for the Wall Mount

Find the drilling templates (scale 1:1) at the end of the manual as a fold-out

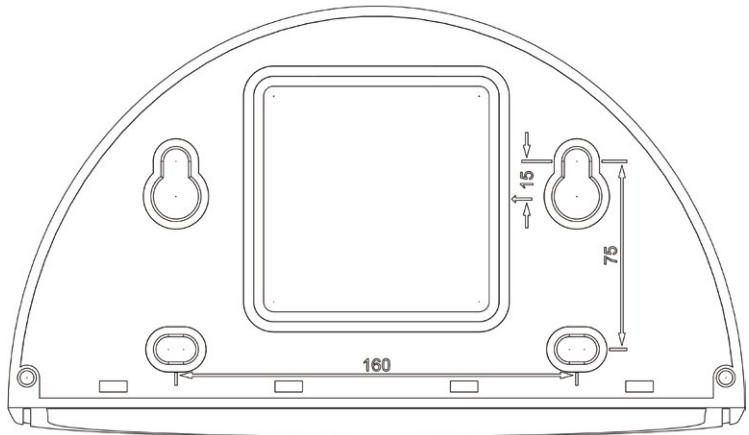

Direct installation over on-wall and flush-mounted wall outlets



**Depth: 201 mm/7.91 in**



**Width: 216 mm/8.5 in**

**Notes**

Find the folded drilling template at the end of the manual.

Make sure that the drilling template is not scaled or adjusted to the paper size when printing the PDF file (enlarged or reduced).

### Scope of Delivery and Required Parts

Please check that all components supplied with the Wall Mount Set are present in the original packaging first. The following additional tools are required for installation:

- **Power drill** for screw anchor holes
- **Screwdriver**
- **MOBOTIX Drilling Templates** (at the end of this manual)
- **Scissors** to cut out the template
- **Pen** to mark the hole positions
- **Materials and tools** needed to connect the pre-installed MOBOTIX network cable in the camera with the on-site network cable
- Clean and soft **cotton cloth**



### 2.6.2 Procedure

1. **Remove the camera housing:** Remove all four Allen screws using the supplied Allen wrench and lift off the outer shell. The screws and outer shell will be needed again shortly.



2. **Remove the camera mounting ring:** Separate the black mounting ring from the camera housing. This ring is not required when mounting the camera to the Wall Mount.

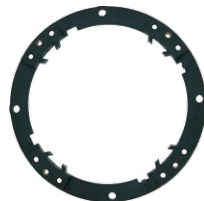

3. **Separate the bottom plate from the Wall Mount:** The bottom plate is used to hold the camera and is only attached and screwed into place during a later step.



4. **Pass the camera cable up through the bottom of the bottom plate:** Ensure the orientation is correct. The spring clips should be on the underside of the bottom plate.



5. **Snap the camera into place on the bottom plate:** Firmly push the camera into the Wall Mount. The plastic spring clips will snap into place when the trapezoidal elements on the rear of the camera housing exactly match up with the corresponding openings on the Wall Mount. Pay attention to the direction of the camera (OBEN / TOP arrow pointing in the direction of the longer wall for ceiling installation in rectangular rooms).



6. **Mount the Wall Mount (without camera):** Stick the black wall sealing to the back of the Wall Mount (remove the adhesive foil first, the surface must be clean and free of grease). Pass the network cable through the large square opening and into the Wall Mount. Use the included screws to install the Wall Mount (without the camera) at the intended position. Pass the network cable through the large square opening on back side of the Wall Mount.



7. **Connect the cable:** Prepare the on-site network cable for connection with the camera patch cable using a standard connector. Excess cable can be stored easily within the Wall Mount.

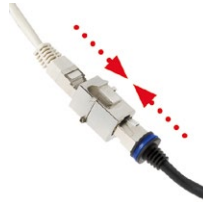

8. **Install the bottom plate with the camera in the Wall Mount:** Connect the camera patch cable to the network cable. Then mount the bottom plate with the camera in the slots from below and fix it in place on the Wall Mount using the 4 Allen screws (Allen wrench included).



9. **Attach the outer shell:** Position the outer shell (without the rubber seal) and tighten all four Allen screws using the included Allen wrench.



10. **Clean the lens:** If necessary, gently clean the front of the lens with a soft cotton cloth. Do not apply excessive pressure to the surface of the glass when cleaning the lens.
11. **Establish a connection to the camera, check the image:** Establish a connection to the camera as described in *Section 3.1* and the following sections. The live image from the camera should be visible on the computer monitor. Check image sections on the computer monitor as well.

## 2.7 Installing the Corner and Pole Mount



### 2.7.1 Mounting Instructions

The Corner and Pole Mount is made from stainless steel and is extremely robust and rustproof. It is used in combination with the Wall Mount described in *Section 2.6*, in the case that a Q25M is to be installed on a pole or building corner. The Wall Mount required for complete installation must be ordered separately.

The mounting pole should have a diameter between 60 and 180 mm. Thanks to the 360° panorama view from above, installing the camera on the corner of a building makes it possible to monitor a range of approximately 270° from one building wall to the other (around the corner) with one single Q25M camera.

By design, the Corner and Pole Mount cannot be mounted above a wall outlet for the camera cabling.

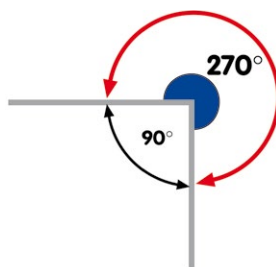



### Required Parts

Please check that all components supplied with the Corner and Pole Mount Set are present in the original packaging first.

**The following additional tools are required for installation as a pole mount:**

- **Screwdriver**
- Materials and tools needed to connect the pre-installed MOBOTIX network cable in the camera with the on-site network cable.

**The following additional tools are required for installation of the corner mount:**

- **Power drill** for screw anchor holes
- **Screwdriver**
- **Scissors** to cut out the template
- **Pen** to mark the hole positions
- Materials and tools needed to connect the pre-installed MOBOTIX network cable in the camera with the on-site network cable.



## 2.7.2 Mounting to a Pole



Use the supplied stainless steel straps to affix the Corner and Pole Mount to a pole.

- Guide the supplied **stainless steel straps** through the openings in the Corner and Pole Mount as shown in the figure. Make sure that you are using the slots of the mount that fit best for the thickness of the pole. The stainless steel straps allow attaching the mount to poles with diameters between 60 and 180 mm.



- Guide the on-site network cable from behind through one of the large round holes of the Corner and Pole Mount. In order to properly protect the cabling, it is best to pass the cabling from the inside of the pole through the Corner and Pole Mount directly into the camera (concealed cabling). **Note: The cable length from the pole should be at least 80 cm!**



- Tighten the **stainless steel straps** on the Pole Mount with a screwdriver. If necessary, the ends of the straps can be cut off.



## 2.7.3 Mounting to a Wall or Building Corner



Use the included screw anchors, screws and washers to affix the Corner and Pole Mount to a building corner.

- Mark the **four screw anchor holes** on the corner of the building, ensuring that the arrows on the mount point upwards. Drill the holes with a 10 mm wall drill.

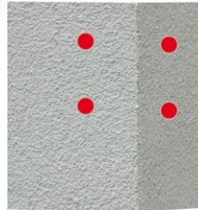

- Pass the on-site network cable through one of the large round holes at the back of the Corner and Pole Mount, then through one of the 16 mm diameter holes on the front of the mount. In order to properly protect the cabling, you should let the cabling run from the inside of the building through the Corner and Pole Mount directly into the camera (concealed cabling). **Note: The cable length from the building corner should be at least 80 cm!**



- Place the included **wall anchors** in the drilled holes and screw the Corner and Pole Mount into place on the corner of the building using the wood screws and washers. Use the supplied drilling template (fold-out at the end of this manual) to mark the positions for drilling the holes.
- Next, install the Wall Mount on the Corner and Pole Mount (see next section).



#### 2.7.4 Mounting the Wall Mount to the Corner and Pole Mount

- Feed the cables **through the appropriate hole at the back** of the Outdoor Wall Mount. The wall sealing on the Wall Mount must be in place already (see *Section 2.6*, «*Installing the Wall Mount*»).



- Use the 6 x 20 mm Allen screws, Ø 6 mm washers and M6 nuts included with the Corner and Pole Mount and **attach the Wall Mount to the Corner and Pole Mount**.



- Then continue with the remaining work steps described in *Section 2.6.2*!



## 2.8 Replacing the MicroSD Card

The camera must be taken down to remove, insert or replace a MicroSD card. To avoid data loss, be sure to deactivate MicroSD card recording in the camera software and reboot the MOBOTIX camera before removing the card.

### Caution

A MicroSD card may only be removed from the camera after you have deactivated Recording to SD Card and rebooted the camera. Failing to do so may lead to data loss!

### 2.8.1 Removing the MicroSD Card

1. **Deactivate recording:** Recording to MicroSD card must be deactivated (**Admin Menu > Storage on External File Server / Flash Device**). If MicroSD card recording is still active, deactivate recording and reboot the camera. *Section 3.4, «MicroSD Card Recording», contains more information on this topic.*

2. **Remove the outer shell:** Remove all four Allen screws using the supplied Allen wrench and lift off the outer shell.



Bayonet catch open



3. **Remove the connection cables:** The connected cables (patch cable, MiniUSB if present) must be removed from the camera first by rotating and opening the bayonet catch (see «Removing the Cable Retainer» in *Section 2.2.2, «Procedure»*).



Carefully loosen the rear casing at the openings on the side with a screw-driver before removing it.



4. **Remove the back of the camera and take out the MicroSD card:** Remove the four screws from the back plate using the supplied 2 mm Allen wrench and carefully lift off the back plate. Gently push on the MicroSD card in the card slot of the camera. The card will be released from the slot and can then be removed from the camera.



Push-push function: only remove the MicroSD card after first gently pushing it in



To use the camera without a MicroSD card, continue with step 2 in the next section.

### 2.8.2 Inserting a MicroSD Card

Push-push function:  
insert MicroSD card,  
then push until it clicks



Bayonet catch closed



1. **Insert the MicroSD card:** Push the MicroSD card into the card slot as shown, until an audible and perceptible click indicates it is in place.



2. **Mount the back plate:** Replace the back plate of the camera housing, ensuring that the back plate screw holes are correctly positioned above the thread inserts.



3. **Screw the back plate tight and replace the connection cables:** Place the four Allen screws back into the back plate and tighten the screws using the supplied 2 mm Allen wrench. The previously removed patch cable must now be reconnected (see «Attaching the Cable Retainer» in Section 2.2.2, «Procedure»).



4. **Attach the outer shell:** Replace the outer shell and screw all four Allen screws tight using the supplied Allen wrench.



5. **Activate recording:** If you have inserted a MicroSD card that has already been MxFFS formatted, you can activate recording under **Admin Menu > Storage on External File Server / Flash Device**. Once the camera has been rebooted, it automatically activates recording.

6. **If you have inserted a new MicroSD card,** it must first be formatted as described in Section 3.4, «MicroSD Card Recording».

## 2.9 Network And Power Connection

### 2.9.1 Notes on Cable Lengths and Power Supply

- Power is supplied to the camera via the camera Ethernet connection (patch or installation cable). We recommend using a MOBOTIX PoE adapter or another similar high-quality PoE product to loop-in the power supply:
  - **One camera:** with the PoE adapter (MX-NPA-PoE or MX-NPA-Box)
  - **Multiple cameras:** with PoE products conforming to IEEE 802.3af (PoE switch)
- The **maximum length** of the network cable for power supply over an Ethernet cable is **100 m**.
- Make sure that you only use switches or routers that support the **10/100 Mbps network interface** of the camera.
- We highly recommend using uninterruptible power supplies (UPS) to provide backup power.
- If you are using IEEE 802.3af or IEEE 802.3at (PoE+) Power-over-Ethernet network components to supply power to MOBOTIX cameras, make sure, if possible, that these components do not have a fan. Since the power consumption of MOBOTIX cameras is very low compared to other products, the reliability of the entire system is increased, thus extending the life of these components.

#### Caution

Appliances with a **maximum total power consumption of 3 W** may be connected to the MxBus connector **and** USB connector **if power is supplied to the camera using PoE class 3**. If **PoE Class 2** is used, **the power consumption of all the connected appliances should not exceed 1 W!**

For information on changing the PoE class, see *Section 2.9.8, «Variable PoE»*.

Connection of additional devices with more than 1 W (via MxBus/USB):  
Max. ambient temperature +50°C /+122°F

### 2.9.2 Connecting the Q25M to the Network Using a Patch Cable

Using a patch cable and an MX-Overvoltage-Protection-Box or MX-NPA-Box offers the following advantages:

- Quick installation/deinstallation
- No shortening of cable even when installing/deinstalling several times
- Hose-proof/dust-proof connection in accordance with IP65
- Additional protection against overvoltages of up to 4 kV when using the MX-Overvoltage-Protection-Box

### Connecting the Patch Cable to an MX-Overvoltage-Protection-Box, an MX-NPA-Box or a Standard Network Outlet

To establish the network connection of the camera using an MX-Overvoltage-Protection-Box or an MX-NPA-Box, remove the blue bayonet catch and the blue sealing plug from the right-hand side of the box. Insert the MOBOTIX patch cable into the box and fasten the cable using the blue bayonet catch.

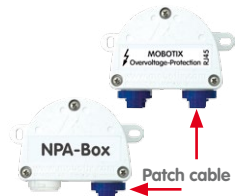

For additional information on how to install an **MX-Overvoltage-Protection-Box** or an **MX-NPA-Box**, open the **Products > Accessories > Interface Boxes** section on [www.mobotix.com](http://www.mobotix.com).

When using a standard network outlet (only for indoor installations), insert the MOBOTIX patch cable of the Q25M directly into the network outlet.

If additional cables are required inside the housing, they must be connected as described in Section 2.9.6, «Connecting a USB Cable» and Section 2.9.7, «Connecting a Two-Wire MxBus Cable».

### 2.9.3 Power Supply Using a Switch

1. Connect the factory pre-installed cable of the camera to the **camera** connector of the PoE adapter.
2. Connect the **LAN/Power** connector of the PoE adapter to the Ethernet connector of the switch/router or the Ethernet port.
3. Plug the RJ45 connector of the power supply unit into the **PC/Power** connector of the PoE adapter.

IP addresses in the figure are shown only as an example

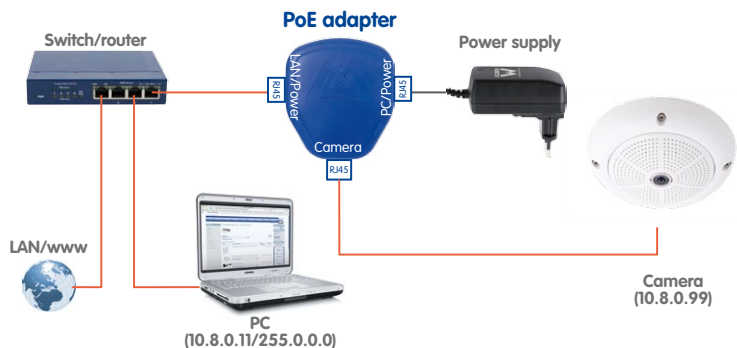



2.9.4 Power Supply When Connected Directly to a Computer

1. Connect the factory pre-installed cable of the camera to the **camera** connector of the PoE adapter.
2. Connect the **PC/Power** connector of the PoE adapter to the Ethernet port of the computer.
3. Plug the RJ45 connector of the power supply unit into the **LAN/Power** connector of the PoE adapter.

IP addresses in the figure are shown only as an example

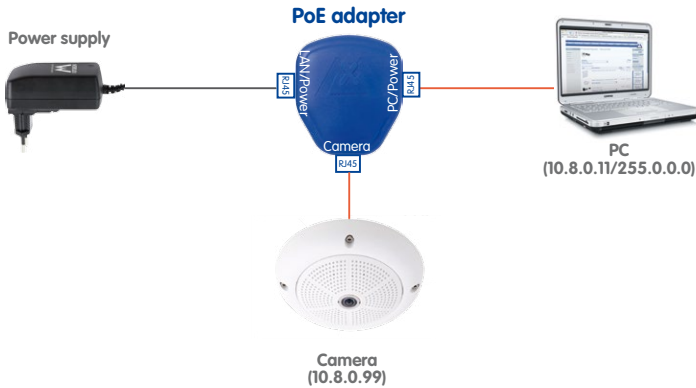

2.9.5 Power Supply with Power-Over-Ethernet Products

Connect the factory pre-installed cable of the camera to the Ethernet connector of the PoE switch/router. The switch/router must support the PoE standards IEEE 802.3af or IEEE 802.3at.

IP addresses in the figure are shown only as an example



Only use USB cables with **angled** plugs inside the housing of the Q25M!



### 2.9.6 Connecting a USB Cable

Using the USB plug (red circle in figure), you can attach existing expansion modules, such as the MOBOTIX ExtIO (USB), the MX-232-IO-Box or external USB hard drives to the camera in a weatherproof and well-protected manner.

#### Procedure

1. In case the camera had already been installed, remove the camera so you can access the connectors on the back.



2. **Remove bayonet catch and USB plug:** Turn the bayonet catch to the left (red arrow in figure), take it off and remove the blue USB plug.

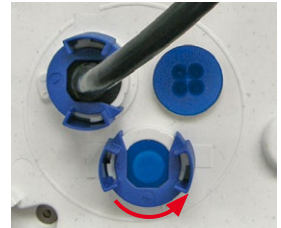

3. **Connect USB cable:** Push the MOBOTIX cable with the angled MiniUSB plug into the connector (red circle in figure).

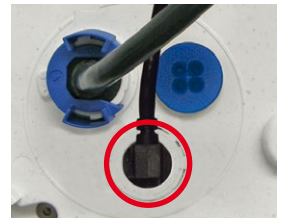

4. **Attach bayonet catch:** Attach bayonet catch and turn it clockwise until it gently snaps shut (see figure).

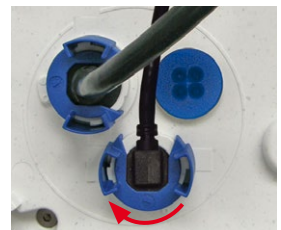

2.9.7 Connecting a Two-Wire MxBus Cable

You can use such a cable to connect additional MOBOTIX modules (e.g., the MX-GPS-Box or the MX-232-IO-Box) to the Q25M.

Note that you can attach two MxBus cables (each having two wires) to the MxBus connector (red circle in figure). Take care not to switch the polarity of the wires. It is recommended to use the same wire color for +/– for the entire MxBus system (e.g., red = +, blue = –).



The length of the entire MxBus wiring must not exceed 50 m/55 yd.

Procedure

1. In case the camera had already been installed, remove the camera so you can access the connectors on the back.
2. **Prepare the MxBus wires:** Remove the blue single wire plug. Strip 5 mm (1/5 in) of insulation from the wire ends, then push each wire into one of the four holes in the single wire plug (this prevents humidity from entering the camera).
3. **Connect MxBus wires:** Push back the blue single wire plug so that you can easily attach the MxBus wires. Attach the MxBus wires by firmly pushing the wires into the corresponding connectors.

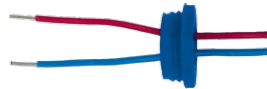

Single-wire plug

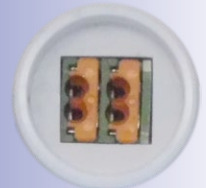

MxBus connector

If you need to remove one of the wires, unlock the connector by pressing on the orange-colored area using a small screwdriver, then pull out the wire.



4. **Close the MxBus connector:** Carefully press the single wire plug into the connector socket and twist the MxBus wire pairs.



## 2.9.8 Variable PoE

The power consumption of the camera depends on the functions in use as well as any peripheral devices connected (see table). PoE classes 1, 2 or 3 may be selected in the browser-based user interface in order to optimally adjust the camera to your system design (PoE switch in use, emergency power concept, etc.).

| PoE Power Level Classes (IEEE 802.3af Standard) |                        |  |
|---|------------------------|--|
| Class   | Max. power consumption | Camera operating mode and peripheral devices   |
| 1   | 0.44 W–3.84 W          | LowPower mode; no peripheral devices (available soon)  |
| 2   | 3.84 W–6.49 W          | Normal mode; max. 1 W for MxBus peripheral devices   |
| 3   | 6.49 W–12.95 W         | FullPower mode; max. 2.5 W for MxBus peripheral devices (for example, MX-GPS-Box and MX-232-IO-Box to MxBus), max. 4 W for peripheral devices to MxBus and USB interface |

### Caution

If the total power consumption of the camera and peripheral devices exceeds the power provided by the PoE switch for the specified class, the switch can disconnect the camera from the power supply. ***In this case, the camera will only be accessible again once the peripheral devices have been disconnected from the camera and the camera has been restarted.***

Variable PoE:  
Multiple cameras  
can be operated  
simultaneously from  
the same switch

The default setting is usually fine, and nothing needs to be changed. However, the PoE power class must be changed in the browser if a higher or a lower power class is required for your application:

1. Select **Admin Menu > Network Setup > Ethernet Interface** (for experts).
2. Click on **Change** under **Power Supply**.
3. A **Power Wizard** will appear to guide you through the PoE configuration steps.
4. Next, restart the camera: Disconnect the camera from the power supply. Then reconnect it, for example, by disconnecting and then reconnecting the Ethernet cable at the PoE switch.

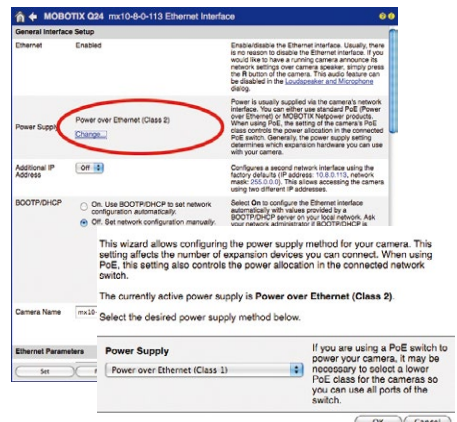

### 2.9.9 Camera Startup Sequence

As soon as the camera's power supply has been established, the two LEDs will show the progress of the startup sequence (see *Section 5.4.3, «LED Signals and LED Configuration»*, in the *MOBOTIX Camera Software Manual Part 2*).



LED default settings:

- 1 Power (an), error (flashing)
- 2 Recording (flashing)

- **Booting:** Immediately after connecting the power supply, the red LED lights up, blinks for two seconds, then stays on permanently red. The camera runs a self-test at this point, and starts the entire system after that. In case of an error, the camera will start using the backup system.
- **Waiting for key pressed:** Both LEDs light up for four seconds. If you press the **R or L key of the camera** during this time, the camera will execute the corresponding function (see *Section 3.2.5, «Starting the Camera with the Factory IP Address»* and *Section 3.2.6, «Starting the Camera with an Automatic IP Address (DHCP)»*). To press a key, use a **paper clip** for example, but **never use sharp or pointed objects!**
- **Ready:** Once the camera software is running, the green LED is on permanently and the red LED flashes. You can now reach the camera via the network (using a browser, MxControlCenter, MxEasy, MOBOTIX App, etc.).

1. Booting

2. Key?

3. Ready

#### Note

During the startup sequence of the camera, the LEDs will always light up, even if they have been deactivated in **Admin Menu > LED Setup**.

Download the free-of-charge MxEasy and MxControlCenter software at [www.mobotix.com](http://www.mobotix.com)

### 3 OPERATING THE CAMERA

#### 3.1 Manual and Automatic Operation – Overview

MOBOTIX cameras do not require any extra software. Thus, you can set up and operate the MOBOTIX camera using a JavaScript-enabled browser on all common operating systems (such as Windows, Linux, Macintosh, etc.). As an alternative, you can also use the MOBOTIX applications MxControlCenter and MxEasy. Follow these steps to set up the camera:

1. **Connect the camera to the network.** Power is supplied directly via the Ethernet cable (see Chapter 2, «Installation»)
2. **Set up the camera's network parameters:**
  - **Manually via a web browser** (see Section 3.2.1, «Manually Setting Up The Network Parameters In A Browser» and below)
  - **Automatically with MxControlCenter/MxEasy** (see Section 3.2.3 and Section 3.2.4) or **via DHCP** (see Section 3.2.7, «Starting The Camera With An Automatic IP Address (DHCP)»)
3. **Configure the camera** using the web-based user interface, MxControlCenter or MxEasy.

Every MOBOTIX camera comes preconfigured with a static IP address in the 10.x.x range (for example, 10 . 8 . 0 . 99). However, local computer networks usually have IP addresses in the 172 or 192 ranges. In order to access a MOBOTIX camera via the network, the camera needs to obtain an IP address in the same address range. You can **set up the network parameters of the MOBOTIX camera using one of the following methods: Manually, using MxCC and MxEasy or by DHCP.**

Camera software in the browser



### 3.1.1 Manually Using a Computer in the 10.x.x.x IP Address Range

You can set up the camera's network parameters using a browser and the embedded camera software. To do this, connect the camera to a computer or a network that is using a 10.x.x.x IP address range (see Section 3.2.1, «*Manually Setting Up The Network Parameters In A Browser*»). Once this has been completed, you can enter the camera's default IP address in the browser's address bar of the computer (see Section 3.2.2, «*First Images And The Most Important Settings In The Browser*»). Next, click on the **Admin Menu** button to open the camera's Quick Installation in the browser's user interface. This is where you can configure the desired network parameters of the camera. Once you have completed the Quick Installation, you can connect the camera with its new network parameters to the desired network.

The default IP address of your camera is printed on a sticker on the front

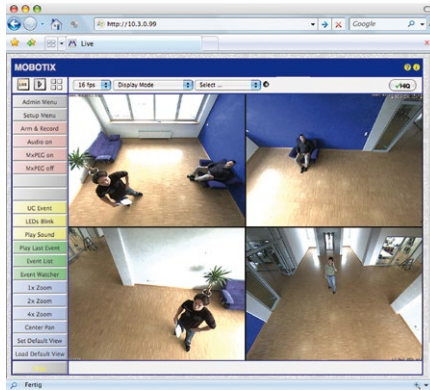

#### Advantages

- The camera does not need to be physically accessible, that is, it may already be mounted.
- No additional software is required.
- The network parameters can be set flexibly through manual entry.

#### Disadvantages

- The computer or the network needs to operate in the 10.x.x.x IP address range or need to be able to access such a network.
- The setup does not work automatically.
- You need to know the relevant network parameters.

### 3.1.2 Automatically Using MxControlCenter or MxEasy

You can set up the camera's network parameters using the free-of-charge video management software MxControlCenter or MxEasy (see *Section 3.2.3* and *Section 3.2.4*). You can also use one of these applications to automatically configure the network parameters of MOBOTIX cameras that are not operating on the same IP address range as the computer.

MxControlCenter  
software (free download  
from [www.mobotix.com](http://www.mobotix.com))

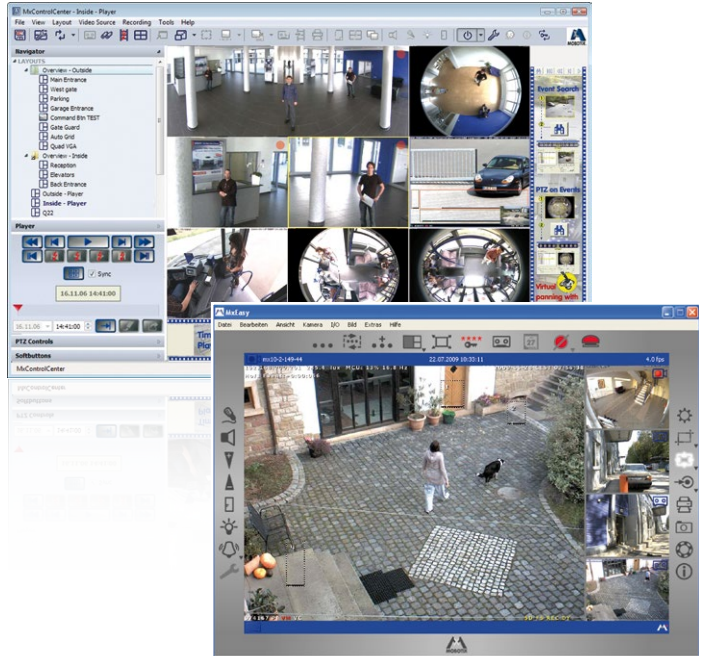

MxEasy  
(free download from  
[www.mobotix.com](http://www.mobotix.com))

#### Advantages

- You can connect the camera directly to the target network.
- The camera does not need to be physically accessible, that is, it may already be mounted.
- The camera can be configured to automatically receive an IP address (optional).
- The network parameters can be manually set (optional).
- You do not need to access the camera software.

#### Requirement

- Either MxControlCenter or MxEasy must be installed on the computer.



### 3.1.3 Automatically Using DHCP

The camera can automatically obtain its network parameters using DHCP (Dynamic Host Configuration Protocol). This requires the network to have a functioning DHCP server (for example, a DSL router with activated DHCP server) and the camera must be booted using DHCP (see *Section 3.2.7, «Starting The Camera With An Automatic IP Address (DHCP)»*). The IP address automatically assigned by the DHCP server will be announced via the camera speaker as soon as the camera has booted successfully.

#### Advantages

- You can connect the camera directly to the target network.
- Network parameters are automatically assigned.
- No additional software is required.
- You do not need to access the camera software.

#### Disadvantages

- The camera needs to be physically accessible as you need to press a key on the camera housing to boot it using DHCP.
- Requires a running DHCP server on the network.



### 3.2 First Images and the Most Important Settings

Once the MOBOTIX camera has been connected to the network, you need to set up the camera's network interface accordingly. This step involves setting up and checking the network parameters of the camera. If your network is already using an IP address in the 10.x.x.x range with a 255.0.0.0 network mask, you do not need to change the camera's network parameters. You can access the camera directly (see *Section 3.2.2*). If your network or computer does not use an IP address in the 10.x.x.x range (for example, in the 192 or 172 ranges), you should follow one of the following methods for changing the camera's network parameters:

- **Manual Setup** (see *Section 3.2.1*)
- **Automatic setup using MxControlCenter or MxEasy** (see *Section 3.2.3* and *Section 3.2.4*)

#### Note

We will use a camera with the factory address 10.8.0.99 in the following examples. Replace this IP address with the IP address of your camera. You will find the IP address of your camera on a small sticker on the camera. Make sure that the IP addresses used in the following examples are not already being used by other devices in the network.

Pressing the "L" key (see *Section 3.2.5*) will prompt the camera to announce its current IP address on the camera speaker

#### 3.2.1 Manually Setting Up the Network Parameters in a Browser

You need a computer that is using a 10.x.x.x IP address in order to manually set up the network parameters of the MOBOTIX camera. The computer's network parameters usually have to be changed for this purpose.

##### 1. Change the Network Parameters of Your Computer:

###### Windows (XP, Vista and 7):

1. Open **Start > Settings > Control Panel > Network Connections**. Clicking on **Properties** opens the dialog box shown.
2. Double-click on **Internet Protocol (TCP/IP)**. On the **General** tab, activate the *Use the following IP address* option. Enter an IP address in the 10.x.x.x range in this field (for example, 10.8.0.11).
3. Once all dialog boxes have been closed, the computer will have the IP address 10.8.0.11.

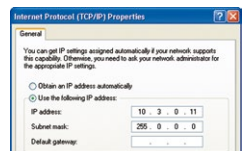

Entry in "Subnet mask" field: 255.0.0.0

## Linux/Unix:

1. Open a terminal as `root` user.
2. Enter the following command: `ifconfig eth0:1 10.8.0.11`
3. The computer is now also using the IP address `10.8.0.11`

## Mac OS X:

1. Open **System Properties > Network**.
2. Select **Ethernet**. In the **Configuration** field, select **Manual** and enter a `10.x.x.x` IP address (for example, `10.8.0.11`).
3. Click on **Apply** on the bottom right-hand side of the dialog box to assign the computer the IP address `10.8.0.11`.



## 2. Set Up the Target Network Parameters of the MOBOTIX Camera:

1. Open a web browser on the computer and enter the default IP address of the MOBOTIX camera in the address bar of the browser (for example, `10.8.0.99`). Pressing Enter displays the user interface of the MOBOTIX camera (see also *Section 3.2.2, «First Images and the Most Important Settings in the Browser»*).
2. Click on the **Admin Menu** softbutton in the user interface of the MOBOTIX camera. The Quick Installation starts automatically once the *admin* user has logged on.

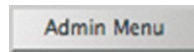

**Note:** The Quick Installation can also be executed at a later stage by opening **Admin Menu > Network Setup > Quick Installation** (see also *Quick Installation in the Camera Software Manual Part 2*).

3. Enter the target network parameters of the camera on the appropriate page of the Quick Installation assistant.

**Note:** The network parameters can also be modified retrospectively via **Admin Menu > Network Configuration > Quick Installation**.



4. Once you have completed the Quick Installation and rebooted the camera, the new network parameters will be activated. The camera can now be connected to the target network and, if required, further configured.

## Default user data

User name: **admin**  
password: **meinsm**

### 3.2.2 First Images and the Most Important Settings in the Browser

Once the MOBOTIX camera has been connected to the power supply and to the network, you can access the user interface with the live camera image in the web browser. Internet Explorer, Firefox, Safari or any other graphical browser with activated JavaScript is suitable. It does not matter which operating system is used.

After entering the camera's IP address in the browser's address bar, you will see the live view of the MOBOTIX camera with its user interface controls, such as softbuttons, buttons for the different camera screens, pull-down menus (Quick Controls), icons for accessing the online help and the camera status, and status information elements.

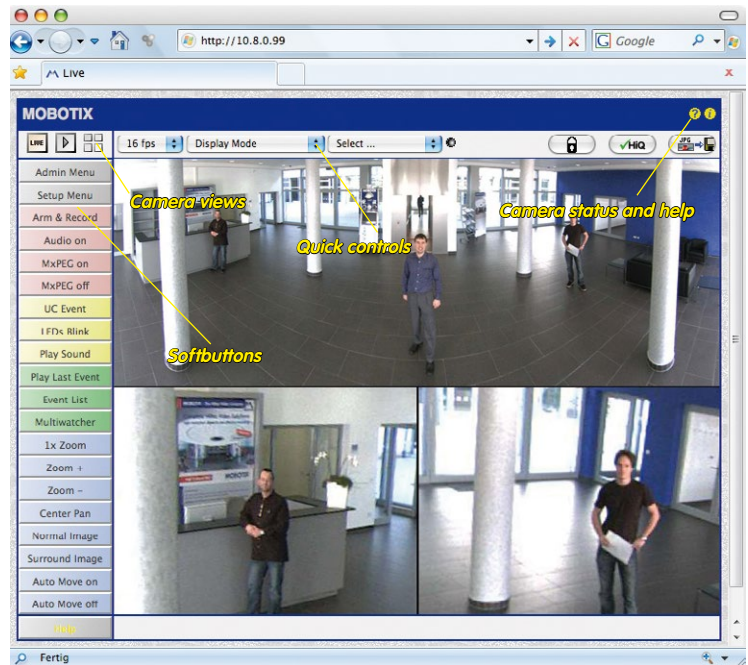

#### Note

##### Default access data for the administration menu

- User name: **admin**
- Password: **meinsm**



Download  
MxControlCenter  
for free from  
[www.mobotix.com](http://www.mobotix.com)

### 3.2.3 First Images and Network Parameter Configuration in MxControlCenter

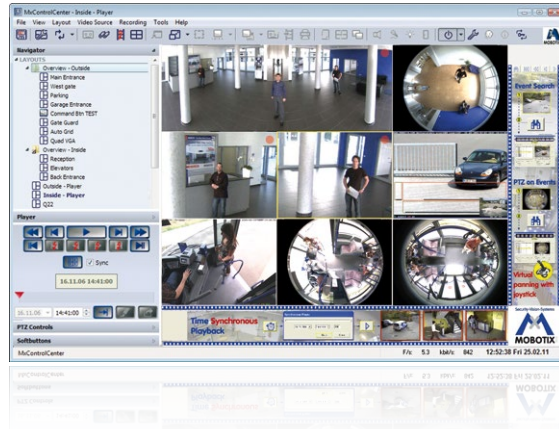

#### Installation

Download the setup file from the MOBOTIX website to install the latest version. The latest versions are available at [www.mobotix.com](http://www.mobotix.com) in the **Support > Software Downloads > MxControlCenter** section.

To install MxControlCenter, simply double-click on the setup file and follow the instructions.

The selected files are copied to the computer (older versions will be removed automatically) and the designated shortcuts are created during the installation process (Desktop, Start Menu, etc.).

#### Caution

MxControlCenter will automatically attempt to find all MOBOTIX cameras in the physically-connected network (that is, even a MOBOTIX camera with a factory IP address of 10 . x . x . x ). Make sure that the **firewall settings** on your computer are low enough so that MxControlCenter is not blocked. If any MOBOTIX cameras are found, MxControlCenter can **automatically reconfigure** them so that they are available in the current subnet of the computer. If you do not have permission to modify these settings on your computer, contact your system administrator for assistance.

**Searching and Displaying Mobotix Cameras**

Launch MxControlCenter after successful installation by double-clicking on the shortcut that was created during installation or the executable file `MxCC.exe` in the installation directory on your computer.

The **Add Video Sources** dialog box appears and the application automatically searches for MOBOTIX cameras in the local network when you launch the program for the first time. Select **Video Source > Add** from the menu to perform a camera search at a later time.

If your MOBOTIX camera is properly connected, it should appear together with the existing video sources in the following list:

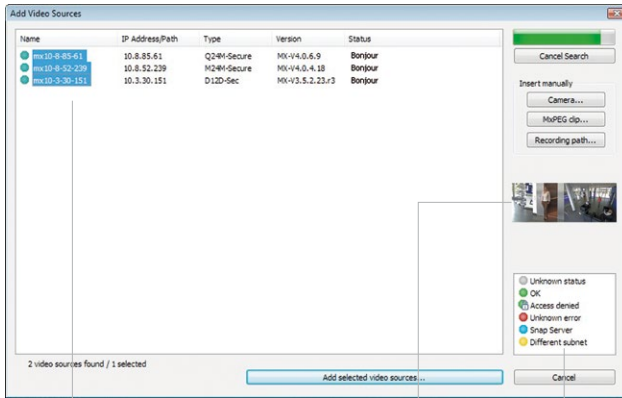

List of video sources

Camera preview



Legend

Automated Search For MOBOTIX Cameras

**Note**

**Video sources** in this context not only refer to MOBOTIX cameras, but also to third-party IP cameras, file server paths, MxPEG clips and analog cameras connected via MxServer (for example, analog dome cameras). These sources are not found automatically and need to be added manually.

### Cameras Are Found But Are Located in a Different Subnet

The symbols in the first column and the legend in the dialog box indicate whether you can access a particular camera directly from the MxControlCenter, which is the case for all cameras designated with  (**OK**). Cameras designated with  (**different subnet**) are located in a different subnet. This usually applies to new cameras or cameras that have been reset to their factory settings.

#### Note

MxControlCenter finds all MOBOTIX cameras, even when the computer and the cameras are not located in the same subnet.

Once you have marked all of the desired video sources in the list with **OK**, you can now select the ones that you wish to display and manage in MxControlCenter. The live image is automatically displayed in the preview window when a camera is selected to help you identify the cameras.

For cameras marked with **Different subnet** or if you want to add additional video sources, follow the instructions in the following sections. You can also display the selected cameras directly in a layout. For more information, see «*Creating a New Layout*» further down.

### Reconfiguring Cameras in a Different Subnet

If one or more MOBOTIX cameras are displayed with the status **Different subnet** (for example, cameras with a factory IP address), MxControlCenter automatically offers to configure the network settings of these cameras. In this case, the application displays the dialog box shown here after you have clicked on the **Add selected video sources** button. Click on **Yes** to configure the cameras to the subnet of the computer.

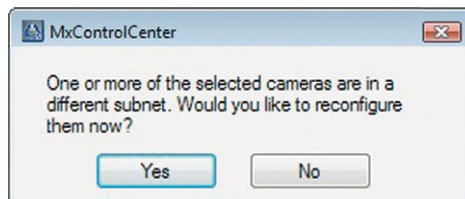



A DHCP server automatically assigns IP addresses for network devices in most networks so that you can automatically select the default setting **Get IP address automatically (DHCP)** in the **Configure Selected Cameras** dialog box.

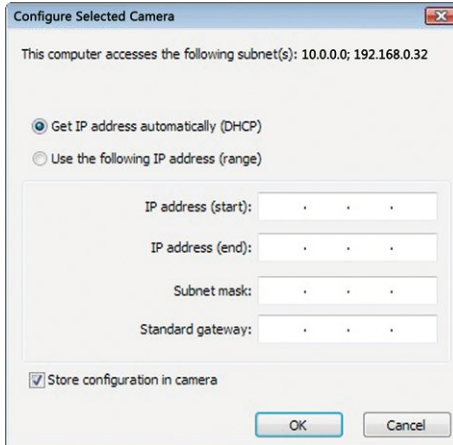

Activate the **Use this IP address/this range** option if the IP address of a particular camera must be assigned manually (for networks with static IP addresses). Obtain the assigned IP address, subnet mask and standard gateway from your network administrator and enter the data. All you have to do is enter the range of IP addresses that includes the addresses of all of these cameras to reconfigure multiple cameras at the same time.



Make sure that the **Store configuration in the camera** checkbox is selected. This setting ensures that the cameras are displayed with the correct network settings even after they have been rebooted. Click on **OK** to close the dialog box.

Wait until MxControlCenter has changed the network settings and rebooted the cameras. The status of the reconfigured camera changes from  (**Different subnet**) to  (**OK**).

### Defining Additional Video Sources

In addition to the MOBOTIX cameras that are found automatically, you can also manually add video sources to the list of video sources for MxControlCenter.

- **Camera:** Here, you can enter the known IP address or DNS name of a MOBOTIX camera or a third-party IP camera if it was not found by the automatic search feature.
- **MxPEG clip:** Adds an MxPEG video clip previously recorded by a MOBOTIX camera as a video source.
- **Recording path:** Adds the path of an external file server where a MOBOTIX camera has recorded audio/video data. The videos or images recorded at that location can now be played back using the **Player** or **Video Search**.

### Editing The Video Source List

Right-click on this list to open a shortcut menu from which you can select all video sources or cancel the selection. You can also use this method to remove from the list some or all of the video sources that you would not like to display or manage in MxControlCenter.

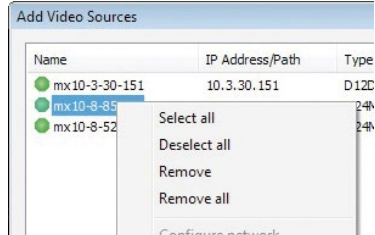

If you have cancelled the camera configuration process or need a password that differs from the camera's factory default password, you can also configure the camera from the shortcut menu at a later date and enter the user name and password required for reconfiguration at that time.

It is also possible to open the **Configure selected cameras** dialog box using the shortcut menu in order to change the camera network parameters.

### Creating a New Layout

Select the camera or other video sources that you would like to display in a layout (a view with a group of selected cameras) in the **Add video sources** dialog box and then click on **Add selected video sources**.

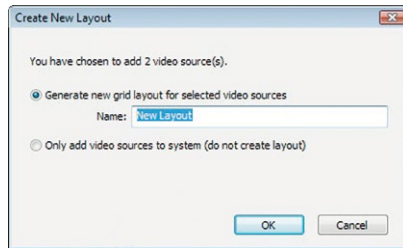

The **Create new layout** dialog box is displayed. If you select the **Generate new grid for selected video sources** option here, MxControlCenter automatically generates a grid layout that displays windows of the same size for all selected video sources. Give each layout a unique name (for example, underground garage).

If you select the second option, the video sources you selected are simply integrated in the MxCC system where you can use them to generate a layout at a later time.

Click on **OK** to confirm.

## 3.2.4 First Images and Network Parameter Configuration in MxEasy

### Installing and Starting MxEasy

Download the current version of MxEasy from the MOBOTIX website ([www.mobotix.com](http://www.mobotix.com) > **Support** > **Software Downloads** in the **MxEasy** area). Double-click the shortcut for the program or the program file.

### Finding Cameras

When you start MxEasy for the first time on a computer, the MxEasy Assistant automatically begins to search for MOBOTIX cameras and displays all cameras found in a list. The camera list will be updated automatically as soon as new MOBOTIX cameras are connected to, or removed from the network.

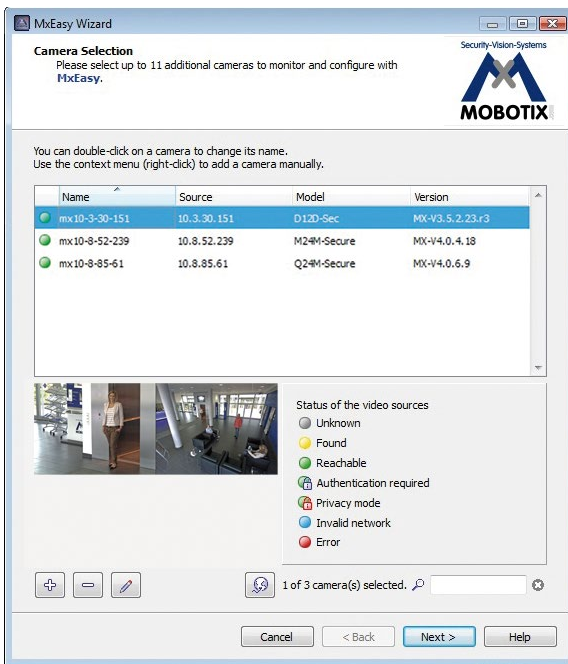

MxEasy also automatically monitors and displays the operating status of all cameras. Cameras that are not on the same subnet as the computer will get a differently colored symbol than the cameras that are on the same subnet. Likewise, the cameras that have an unknown password or for which no user name/password combination has been specified in MxEasy will be displayed in a different color. The following section *“Reconfiguring Network Addresses Of Cameras”* contains information about cameras with the status **Invalid network** (for example, all new MOBOTIX cameras with factory settings).



Download MxEasy  
for free from  
[www.mobotix.com](http://www.mobotix.com)

\*Bonjour: automatic recognition of network services in IP networks

### Reconfiguring Network Addresses of Cameras

Using Bonjour\*, MxEasy finds not only cameras on the same network as your computer, but also MOBOTIX cameras located in other subnets (the **Invalid Network** status). In such a case, you would not be able to establish any connection to cameras in a different network or subnet (without going into much further detail regarding TCP/IP network configurations). This is possible, for example, when a camera with a factory IP address is connected to a network in which a DHCP server automatically assigns the IP addresses. MxEasy can automatically configure such a camera so that it is "integrated" into your existing network. To do so, you only have to select the affected camera in the list and then click on **Continue**.

After a security prompt, a new dialog box for configuring the selected camera is displayed.

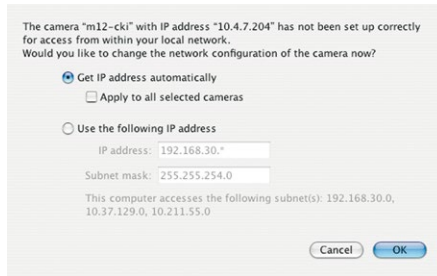

If your computer automatically obtains its IP address from a DHCP server, then this is certainly the best choice for that specific camera and most likely for all other cameras that have been found in a different subnet (**Get IP address automatically** option).

If you have assigned a static IP address to your computer, you will probably want to assign static IP addresses (issued by your system administrator) to every camera (the **Use this IP address** option). Normally, you enter the same configuration used for the network settings of your computer.

When you click on **OK**, the selected cameras are automatically reconfigured and they are located in the same subnet as the computer.

### Integrating and Displaying Cameras

After a camera has been reconfigured, it has the status **Accessible** and can be integrated into MxEasy. The MxEasy Assistant then displays the **Define Integration Mode in MxEasy** dialog box.

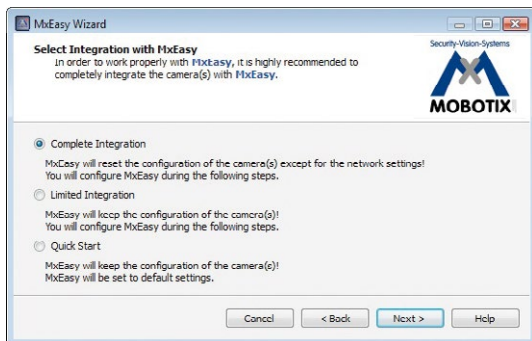

Here, you can jump directly to the main window of MxEasy with the current live camera image by activating the option **Quick Start**. However, some required detailed configurations may have to be made at a later time (for example, password protection, available bandwidth). For this reason, we recommend activating the option **Complete Integration** and complete the remaining dialog boxes of the MxEasy Assistant until the main window appears.

If one of the integrated cameras includes a **Q25M**, the MxEasy Assistant opens an additional page where you can specify the **mounting positions** (*Ceiling, Wall, Floor*) and **display modes** (*Panorama, Surround, etc.*) of the individual sensor modules.

After you are done with the MxEasy Assistant, the application's main window appears and displays the first camera:

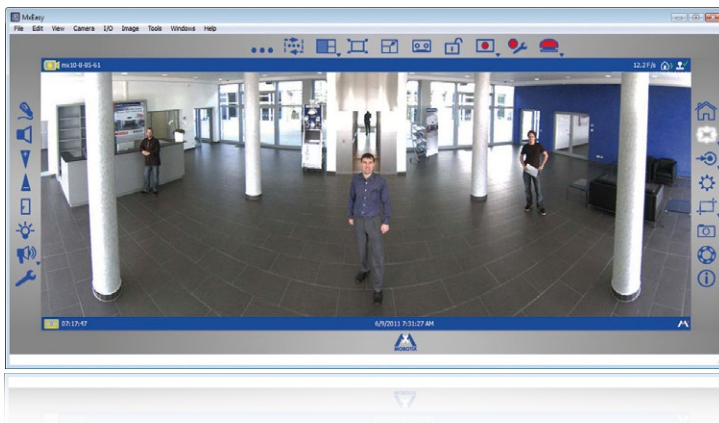

Main window with Panorama image of a Q25M

For more information, see the **MxEasy User Manual**, which can be downloaded as a PDF file from the MOBOTIX website: [www.mobotix.com](http://www.mobotix.com) > **Support** > **Manuals**.

Passwords and camera settings will not be changed

### 3.2.5 Starting the Camera with the Factory IP Address

Under certain circumstances, you may have to reset the camera to its factory IP address. This could be the case, for example, if the IP address has been lost or the camera does not respond to the last known IP address. Proceed as follows to start up the camera with its factory IP address:

1. If the camera is powered on, disconnect the power supply by unplugging the corresponding cables and then reconnect the power supply.
2. Wait until both LEDs light up simultaneously for the first time.
3. **Press the L key within the next four seconds and hold it down** (if you need to try again, go back to Step 1). Use a **paper clip** for this purpose but **avoid using sharp or pointed objects!**

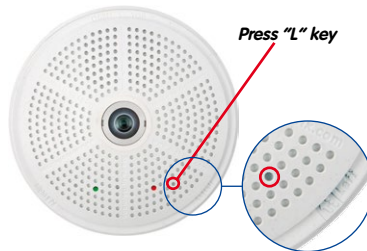

4. **After about 30 to 45 seconds**, the camera emits a single sound (“boing”).

The camera has finished booting and can now be used (e.g., MxEasy, MxControlCenter, MOBOTIX App, web browser).

#### Notes

If you use the camera's **L key** to load the factory network configuration, this configuration is not automatically saved in the camera's flash memory. When the camera is next rebooted without using the **L key**, the last stored network configuration will be used. To permanently store the new network configuration in the camera's flash memory, open **Admin Menu > Store**.

As opposed to resetting the camera using **Admin Menu > Reset configuration to factory defaults**, the user information will **not** be reset if the camera is booted using the factory IP address.

Make sure you store the default network configuration to the permanent flash memory

## 3.2.6 Starting the Camera with an Automatic IP Address (DHCP)

If your network has a DHCP server, you can start the MOBOTIX camera with DHCP support. The camera automatically obtains an IP address from the DHCP server and announces the new network data. Please note that this announcement can only be heard if the camera is connected to an external speaker.

1. If the camera is powered on, disconnect the power supply by unplugging the corresponding cables and then reconnect the power supply.
2. Wait until both LEDs light up simultaneously for the first time.
3. **Press the R key within the next four seconds and hold it down** (if you need to try again, go back to Step 1). Use a **paper clip** for this purpose but **avoid using sharp or pointed objects!**

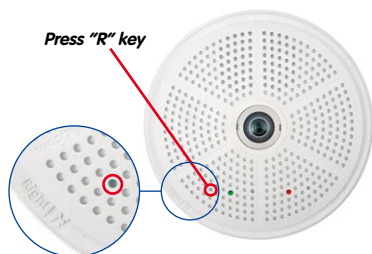

4. **After about 30 to 45 seconds**, the camera emits a double sound (“boing boing”).

The camera has finished booting and can now be used (e.g., MxEasy, MxControlCenter, MOBOTIX App, web browser).

### Notes

Starting the camera with an automatic IP address (DHCP) is only **temporary**. The network configuration of the camera can be permanently set to DHCP under **Admin Menu > Ethernet Interface**.

Make sure that the network has a functioning DHCP server when starting the camera with DHCP support. If this is not the case, the camera cannot obtain a valid IP address and will use its last IP address.

You should also make sure that the cameras always obtain the same IP addresses by permanently assigning the MAC addresses of the cameras to the desired IP addresses.

In case of an error, the camera uses its last IP address

### 3.3 Virtual PTZ and Full Image Recording

#### 3.3.1 Preparing the Virtual PTZ Function

The virtual PTZ function allows you to use a mouse or joystick to continuously zoom in on images from the selected video source and “virtually” move the enlarged image section within the entire image sensor area.



Greater ease of use  
through a joystick

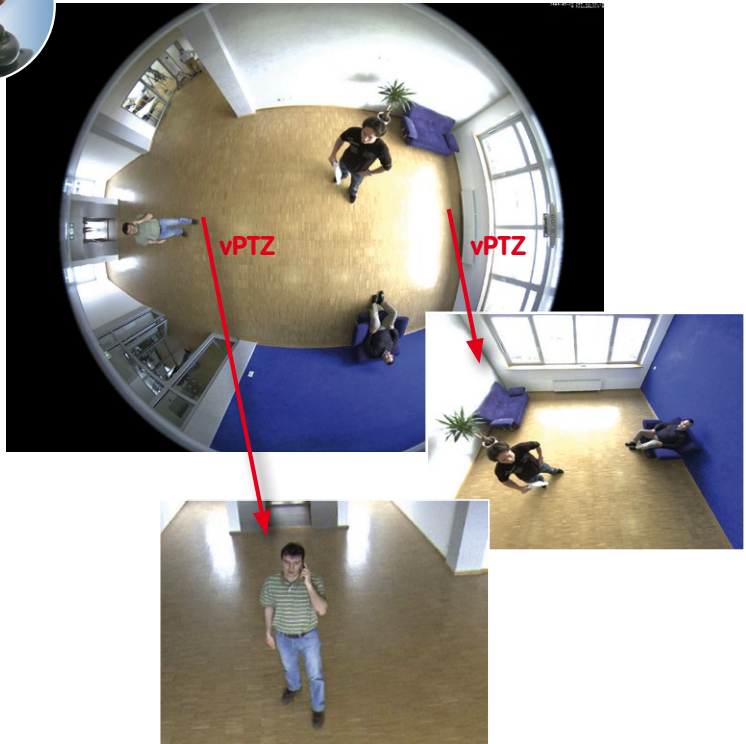

#### Operation Using the Mouse and Scroll Wheel

The vPTZ function of the Q25M can be controlled in the browser using the mouse. This position becomes the new image center by clicking on any position on the image displayed on the monitor. The image moves accordingly and the image distortion is automatically corrected. The **scroll wheel** can be used to control the zoom function. This functionality is disabled in the default settings of the camera and must therefore first be activated. To do this, go to **Setup Menu > vPTZ Settings**, disable **Lock Mouse Wheel Zoom**, click on **Set** and then on **Close** to save your settings. You can now use the scroll wheel to zoom + (roll upwards) or zoom - (roll downwards).



## Operation Using a USB Joystick

A standard USB joystick can drastically improve vPTZ operation for the user – in the browser, in MxEasy, and in the MxControlCenter (however, MxCC is also equipped with a virtual joystick that can be operated using the mouse). Please first install the joystick on the PC according to the manufacturer's instructions.

In order to use a USB joystick in the browser, make sure that you have a PC with a Windows operating system and the latest version of Internet Explorer and that the **“ActiveX” mode in the camera software (browser) is activated:**

- Switch to **Browser** in the Quick Control.
- Under **Browser**, select the option **ActiveX** in the field to the right. The USB joystick can then be used until the browser is closed.
- To store the setting permanently, ActiveX must be activated in the **Admin Menu**. To do so, use **Language and Start Page** in the Admin Menu.
- Under the page options, select the **ActiveX** operating mode.
- Store the settings permanently in the camera by clicking on **Set** and **Close**.
- The joystick can now be used.

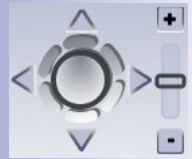
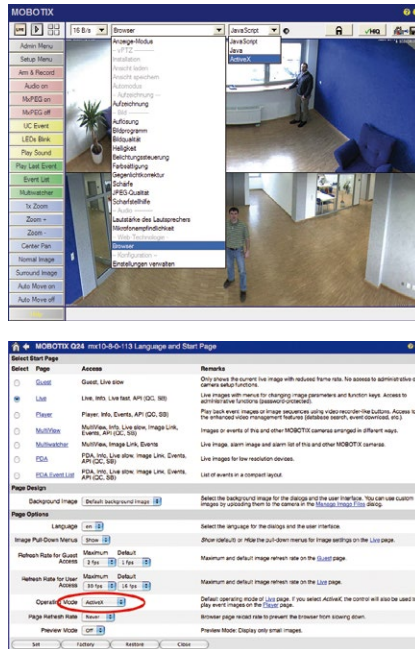

## Notes

You will find more information and details on vPTZ in the **Camera Software Manual Part 2, Section 4.3.6, «Virtual PTZ»**, the **MxEasy** manual, **Section 2.4.1, «Activating the PTZ Features»**, the **MxControlCenter** manual, **Section 2.4.6, «Using the vPTZ Features»** and **Section 3.1.4, «The “PTZ Controls” Section In The Sidebar Panel»**.

Current versions of all manuals can be downloaded anytime from the MOBOTIX website [www.mobotix.com](http://www.mobotix.com) under **Support > Manuals**).

### 3.3.2 Full Image Recording

It is possible to record a **full image**, regardless of the live image stream that is being displayed. This ensures that the recording always contains the full image of the lens used, even though the operator may have used the vPTZ features to zoom into the image in order to examine a specific detail.

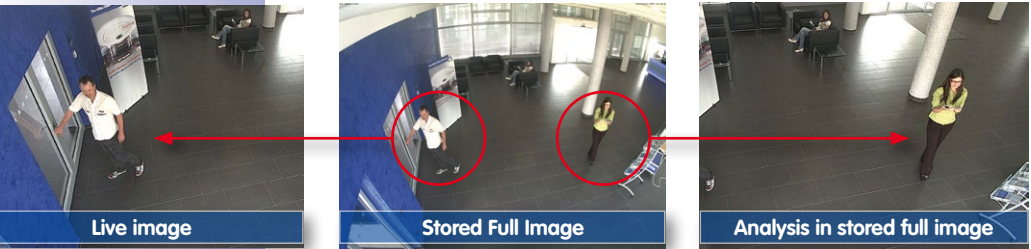

Stored full image:  
Original camera image  
without distortion or  
image correction

This means that you can use the vPTZ features in VGA resolution to pan, tilt and zoom in the live image while the camera is, for example, recording full images at 1 fps in MEGA or QXGA resolution.

In **MxEasy** or **MxControlCenter**, the recorded full images may be prepared for the user with the vPTZ functions (for example, panning and zooming in on an image detail such as a doorway).

If **full image recording is not activated**, only the last displayed live image will be saved (save what is seen). The **main benefit** of live image storage is to ensure that the full power of the camera processor is used for live image correction and maximum frame rates. The **main advantage of full image recording** lies in the special functionality of the D14D, in that it can always ensure the availability of a maximum size (full) image for later searches, despite vPTZ actions carried out on the live image. The mechanical limitations of motor-driven PTZ cameras mean that they simply **cannot** provide this unique advantage to the user!

#### Notes

**Post-event search in the full image:** If you are using Full Image Recording on D14D cameras, you should use at least MEGA resolution when storing. This will facilitate later searches in **MxControlCenter** or **MxEasy**. The advanced distortion correction features require this function to deliver satisfactory image quality.

**Full image recording on:** Due to the increased processing time, full image recording reduces the data rate of the live image stream, which may drop by around 10 to 30 percent. We therefore recommend reducing the frame rate for storage as much as possible to affect the live image stream as little as possible.

**Full image recording off:** The event that triggered a video motion (VideoMotion VM) window may not be in the recorded sequences while the window was not displayed at the time.

## Virtual PTZ and Full Image Recording

### Activate/Deactivate Full Image Recording in the Browser

To configure this feature, open the **Setup Menu > Event Control > Recording** dialog box and activate or deactivate the **Full Image Recording** option.

The screenshot shows the 'Recording' configuration page for a MOBOTIX Q24 camera. The 'Full Image Recording' option is set to 'On' and is circled in red. The 'Explanation' for this option states: 'Activate Full Image Recording: On will always record the Full Image of the sensor with the specified parameters. On will record the visible image.' Other settings include 'Arming' (Enable), 'Digital Signing' (Off), 'Recording Status Symbol' (Off), 'Terminate Recording (TR)' (Off), 'Recording (REC)' (Event Recording), and 'Start Recording' (All).

| General Settings         | Value           | Explanation   |
|--------------------------|-----------------|---|
| Arming                   | Enable          | <b>Arm Recording:</b><br>Controls camera recording:<br>Enable: activate Recording.<br>Off: deactivate Recording.<br>SI: Recording armed by signal input.<br>CS: Recording armed by custom signal as defined in <a href="#">General Event Settings</a> .<br>From Master: copies Recording arming state from master camera. |
|                          | (no time table) | <b>Time Table Profile:</b><br>Time table profile for time-controlled recording. ( <a href="#">Time Tables</a> )   |
| Digital Signing          | Off             | <b>Digital Signing:</b><br>Digitally sign the recorded image files using the X.509 certificate of the web server. Manage X.509 certificates of the <a href="#">web server</a> .   |
| Recording Status Symbol  | Off             | <b>Activate Recording Status Symbol:</b><br>On will draw a symbol in the image to visualize the current arming and recording status.  |
| Full Image Recording     | On              | <b>Activate Full Image Recording:</b><br>On will always record the Full Image of the sensor with the specified parameters. On will record the visible image.  |
| Terminate Recording (TR) | Off             | <b>Activate Terminate Recording:</b><br>Terminate recording if an event is detected. Use this option to freeze stored images. <a href="#">Click here to resume recording.</a>   |
| Storage Settings         | Value           | Explanation   |
| Recording (REC)          | Event Recording | <b>Recording Mode:</b><br>Type of event and story recording.<br>Snap Shot Recording: stores single JPEG pictures.<br>Event Recording: stores stream files for every event using MJPEG codec.<br>Continuous Recording: continuously streams videodata to stream files using MJPEG codec.                                   |
|                          | Include audio   | <b>Record Audio Data:</b><br>Store audio data in stream file if available. Enable and configure <a href="#">microphone</a> .  |
| Start Recording          | All             | <b>Start Recording:</b><br>Select the events which will start recording. Use [Ctrl]-Click to select more than one event. Events in brackets need to be activated first. EC or EL for filtered events.   |

The screenshot shows the 'Full Image Recording' configuration page. The 'Image Size' is set to 'QXGA (2048x1536)', 'JPEG Quality' is set to '60% (High)', and 'Text Display' is set to 'Date & time'. The 'Explanation' for 'Image Size' states: 'Image Size: Factory default: Mega (1280x960)'. The 'Explanation' for 'JPEG Quality' states: 'JPEG Quality: Factory default: 60%'. The 'Explanation' for 'Text Display' states: 'Text Display: The Date & time option will only display date and time.' The 'Date and Time' section is also visible, with the option 'Date & time' selected.

| Attribute    | Value            | Explanation   |
|--------------|------------------|---|
| Image Size   | QXGA (2048x1536) | <b>Image Size:</b><br>Factory default: Mega (1280x960)                          |
| JPEG Quality | 60% (High)       | <b>JPEG Quality:</b><br>Factory default: 60%                                    |
| Text Display | Date & time      | <b>Text Display:</b><br>The Date & time option will only display date and time. |
|              | Date & time      | <b>Date and Time:</b><br>Select format of date and time.                        |

### 3.3.3 Special Q25M Configuration in the Browser

Thanks to its hemispherical lens, the MOBOTIX Q25M provides certain special configuration options for the image settings. Depending on where the camera is mounted (ceiling or wall) and on the live image display preferred by the user, certain important basic settings and, if necessary, their adjustment must be configured when a Q25M is first installed.

A corresponding adjustment of the image setting is strongly recommended if the on-wall set is mounted with an inclination of 10 degrees (available as a Q25M accessory).

#### Configuration of the Q25M Basic Parameters

Complete the steps described below in the browser window:

1. **Log onto the camera and boot it** as described in *Section 3.2*.
2. **Select mounting position wall/ceiling/floor:** Click on **Installation** in the Quick Control panel and then select **Wall**, **Ceiling** or **Floor** according to the mounting position of the camera. **Ceiling** always means that the orientation of the camera or sensor module is from **top to bottom** and for **Floor**, the camera or sensor module's orientation is from **bottom to top**.

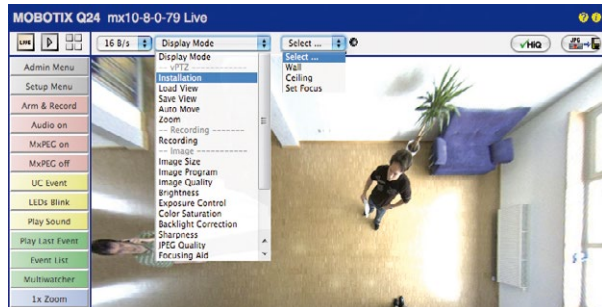

As a result, you will get a **perspective-corrected panorama view** for each image sensor matching the specified mounting position. Panorama view is set as a factory default and it can be changed as described below.

3. Switch to the **Display Mode** Quick Control.
4. Set the mode that you want to be the standard view. For demonstration purposes, the descriptions below describe the typical display mode for the wall mount and the ceiling mount, **Panorama** and **Surround** respectively. Every other display mode can be operated in the same way.

Wall-Mounted: Setting and Correcting the “Panorama” Standard View



High-resolution 180° panorama

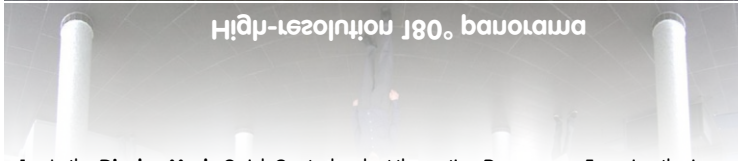

High-resolution 180° panorama

Camera live image with panorama correction

1. In the **Display Mode** Quick Control, select the option **Panorama**. Examine the image that is now displayed. If the section meets your expectations, no further adjustment is necessary and panorama configuration is complete. To change the image section to meet your specific expectations, continue with Step 2.

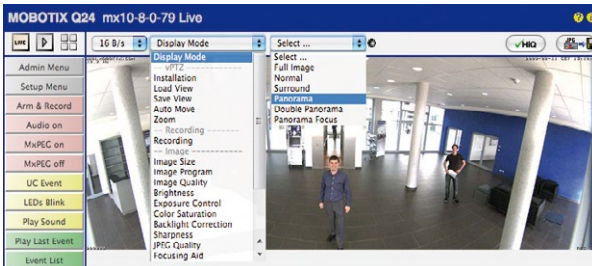

Camera live image without MOBOTIX panorama correction with Quick Controls visible

Note

The currently visible image section may differ from the desired image section due to the installation position or any accessories in use, for example. However, it is not necessary to physically move the camera, as in this case the browser alone can be used to adjust the visible panorama image by zooming, panning and tilting. Tilted vertical lines may also be optically straightened to the image edges using the panorama correction function. These tilted lines are primarily caused if the camera or sensor module is tilted (for example, due to mounting with 15° wedges) or if the image tilt is modified.

- Click on the **lock icon**. Clicking on the lock once opens it (lock clasp is raised). The lock prevents execution of later vPTZ actions, which could also unintentionally modify the view you configure. This holds for all overview display modes, that is, also for Panorama/Focus, Double Panorama and Surround.

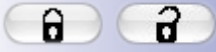

Open lock



- A new **icon for processing the panorama image** appears in the top left corner of the camera image. Enlarge the image by clicking on the icon once (OnScreen Control appears).



Click on the icon

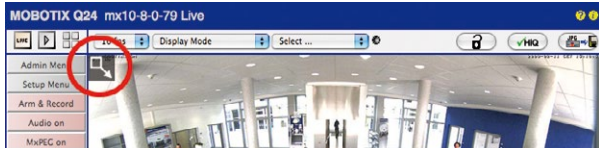

- Using the **OnScreen Control** visible in the live camera image, you can now change the displayed live camera image as desired (panning, tilting, zooming, rotating and panorama correction; see fig. on the right). When doing so, the vPTZ function using the mouse or joystick is deactivated. In case of a S14D with two sensor modules, click on the corresponding camera image (right/left) to edit it (highlighted with a yellow frame).



Camera live image with panorama correction with OnScreen Control visible

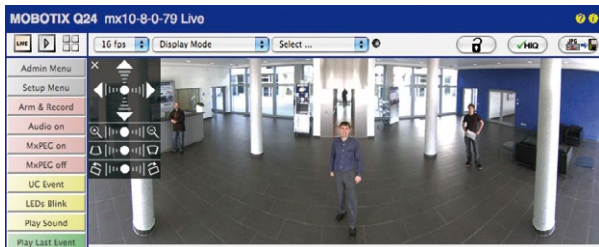

- After you have modified the desired setting, close the control panel (x in the top left hand corner).
- Click on the lock icon again** to close it (lock clasp is down). The panorama image setting is then locked until the camera is next restarted.

**Caution**

To permanently save the standard image setting defined for the Q25M, go to the **Store Complete Configuration** option in the **Manage Settings** Quick Control. The settings will then remain in effect, even after rebooting.

**Functions Of The Q25M OnScreen Control**

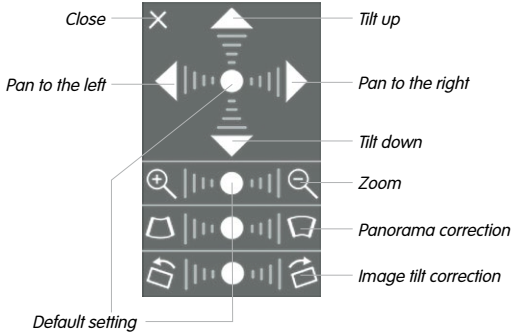

To use the OnScreen Control, click on the arrows in the top area for shifting the image section. In the bottom areas, which are displayed when needed, click to the left and/or right of the center point.

The same applies for every area: **The further away that you click from an area's center point, the greater the change triggered.** To reset an area, click on its center point again.

During panorama correction, clicking between the two trapezoid symbols straightens the left or right tilting lines, which are best visible at the edges of the image section.



Depending on the mounting position (ceiling, wall, floor), panorama correction and mounting error correction may not be available!

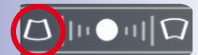

Bring columns together at the top (necessary to correct the example on the left)



Bring columns together at the bottom

### Ceiling-Mounted: Set North (User-Defined North Direction)

Once the Q25M has been mounted on a ceiling, you need to specify its North direction. This is not the “true” direction of North but rather the **main line of sight or the focus of the lens**. It serves as a reference for the North direction in the **Surround** and **Double Panorama** display modes (the **Ceiling** option was already selected in the **Installation Type Quick Control**).

1. In the case of a double image, click on the corresponding sensor module (camera image) and select the **Normal** option from the **Display Mode Quick Control**.



2. **Rotate the live image** in the desired direction using the mouse or a joystick connected to the computer.



For vPTZ use and the configuration of a USB joystick, see Section 3.3.1



- In the **Installation** Quick Control, select the **Set North** option.

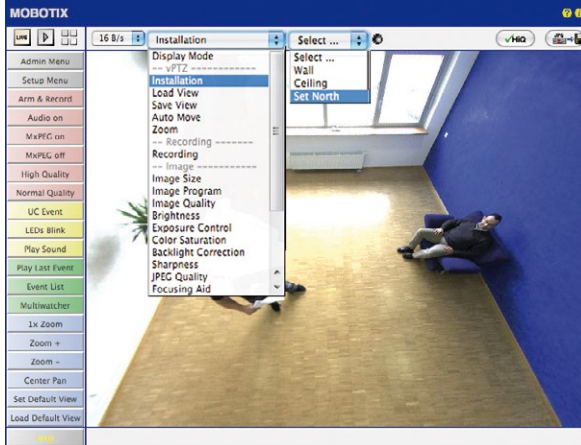

- Store the desired North direction permanently by first activating the checkbox and then clicking on **Yes**.

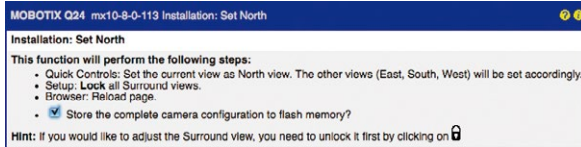

- You have now set the North direction for the **Surround** and **Double Panorama** display modes. In the next step, you can set these views as the standard view for the camera live image.



Caution: No OnScreen Control is available in "Double Panorama" mode



In the **Display Mode** Quick Control, select the option **Surround or Double Panorama**. You can fine-tune the views using the vPTZ via mouse or joystick and, as described above, by unlocking and locking the standard view using the lock icon (open lock, correct display and close lock again).

#### Note

For each of the **subviews** (*North, East, etc.*), the **OnScreen Control** on the side can be used to adapt it (open lock, click on subview, adapt view, click on next subview, adapt view and close lock again).



## 3.4 MicroSD Card Recording

### 3.4.1 Introduction

Flash-based storage devices (MicroSD cards, USB sticks and solid-state drives) do not contain any moving parts as compared to the commonly used hard drives. Flash-based storage devices are compact and highly resistant to moisture and vibrations. They feature low energy consumption and they do not lose any data in the event of a power failure, meaning that they are ideal for use with MOBOTIX cameras.



Flash memory devices: more robust than hard drives

#### Number of Write/Delete Cycles Per Flash Storage Cell

The number of write/delete cycles of every storage cell of a flash device is limited. The controller of the flash device automatically detects individual flash cells that are no longer functioning. The contents of the faulty cell will then be rebuilt using a checksum and will be moved to a properly working spare cell. The faulty storage cell will be marked as “bad” and will no longer be used. No data is lost in this process.

In addition, MOBOTIX cameras constantly monitor activated flash storage devices. MOBOTIX has developed a technology to test the wear of the flash device by logging the number of write/delete cycles (patent pending). The flash memory wear is automatically displayed in the status bar in the live camera image but it can also be viewed at any time in the **Admin Menu > Camera Status** dialog box.

#### Conservative Memory Usage Thanks to MOBOTIX MxFFS File System

MxFFS formatting of the MicroSD card means that MOBOTIX camera software will use the flash device as evenly as possible, thus allowing for the maximum possible number of write/delete cycles. This also means that all storage cells of the flash device will be written and deleted with the same frequency, if possible. MOBOTIX technology increases the life of the flash device considerably and also improves the security and the reliability of the storage process.

#### Storage Requirements and Life Expectancy of MicroSD Cards

The life expectancy of a MicroSD card increases proportionally to the storage capacity, since the camera software will execute fewer write/delete cycles on each storage cell. The first deletion will begin once the SD card has been filled to capacity (first full cycle).

All specifications are based on calculated averages

| 32 GB MicroSD Card: Storage Requirements |           |           |          |            |            |
|--|-----------|-----------|----------|------------|------------|
|  | 6 fps CIF | 6 fps VGA |          | 1 fps MEGA | 1 fps QXGA |
|  | M-JPEG    | M-JPEG    | MxPEG    | M-JPEG     | M-JPEG     |
| File size single image                   | 15 kB     | 45 kB     | –        | 120 kB     | 240 kB     |
| Storage required per second              | 90 kB     | 270 kB    | 75 kB    | 120 kB     | 240 kB     |
| Storage required per 24 hrs              | 7.8 GB    | 23.5 GB   | 6.5 GB   | 10.4 GB    | 20.8 GB    |
| Time for one full cycle                  | 4 days    | 1.3 days  | 4.8 days | 3 days     | 1.5 days   |

| 4 GB MicroSD Card: Storage Requirements |           |           |            |            |            |
|---|-----------|-----------|------------|------------|------------|
|   | 6 fps CIF | 6 fps VGA |            | 1 fps MEGA | 1 fps QXGA |
|   | M-JPEG    | M-JPEG    | MxPEG      | M-JPEG     | M-JPEG     |
| File size single image                  | 15 kB     | 45 kB     | –          | 120 kB     | 240 kB     |
| Storage required per second             | 90 kB     | 270 kB    | 75 kB      | 120 kB     | 240 kB     |
| Storage required per 24 hrs             | 7.8 GB    | 23.5 GB   | 6.5 GB     | 10.4 GB    | 20.8 GB    |
| Time for one full cycle                 | 12 hours  | 4 hours   | 14.4 hours | 9.2 hours  | 4.4 hours  |

### Caution

The MicroSD card's service life depends on production quality and frequency of use. Set the type of recording (event-controlled or continuous recording, frame rate, resolution) according to your specific requirements.

We recommend changing the pre-installed, high-quality 4 GB MicroSD card once a year if you have it constantly set to continuous recording.

### Monitoring the Cell Wear of Flash Storage Devices (Patent Pending)

MOBOTIX uses its own technology for this purpose and has a pending patent. You can view the flash wear in the status bar of the live image or by opening **Admin Menu > Camera Status**. In addition, the camera can also send a warning message (for example, via e-mail) as soon as a critical error is detected when data is written to the SD card (**Admin Menu > Error Notification Function**.). The MicroSD card can then be replaced to ensure that any existing data is not lost.

| File Server / Flash Device |                        |
|----------------------------|------------------------|
| Type                       | SD Flash Card          |
| File System                | MxFFS                  |
| Flash Wear                 | 1%                     |
| Transfer Buffer Usage      | 0% (0: 0%, max: 0%)    |
| Lost Event Images          | 0                      |
| Sequences                  | 1 (1 files)            |
| Newest Sequence            | 1970-01-01 01:00:00 #0 |
| Oldest Sequence            | 1970-01-01 01:00:00 #0 |
| Current Usage              | 4.0 MBytes (0.4%)      |
| Max. Size                  | 936 MBytes             |

3.4.2 Formatting the MicroSD Card

Before a MOBOTIX camera can store image and video sequences on a MicroSD card, the card needs to be formatted as MxFFS (MicroSD cards supplied by MOBOTIX are already MxFFS-formatted). The following steps are necessary to format a storage device (**Admin Menu > Storage on External File Server / Flash Device**):

1. Make sure that there is a MicroSD card in the card slot of the MOBOTIX camera.
2. Click **Format** in the **SD Memory Card** line.

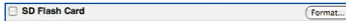

3. Note down the characters shown in the **Encryption password** field or enter your own password. Next, click **OK**.

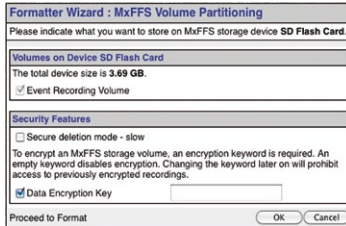

**Note:** The **Secure deletion – Slow** option will ensure that any data on the MicroSD card is overwritten completely so that the data cannot be recovered in any way. However, keep in mind that this kind of safe formatting takes considerably more time.

4. In the next dialog box, enter the user name and the password of a user of the **admins** group and click **OK** to confirm.



The MOBOTIX camera now starts formatting the card. It takes 5 to 12 minutes to format an 8 GB MicroSD card if the **Secure deletion – Slow** option is disabled. If **Secure deletion – Slow** is enabled, this may take anywhere between 3 and 14 hours.

Once the formatting has been completed, you can activate the MicroSD card for recording (see next section).

**Caution**

Make sure that you always wait until the formatting process has been completed before accessing the camera again. If the **Secure deletion – Slow** option is disabled, this usually takes just a few minutes. You can only access the MicroSD card once MxFFS formatting has been completed.

Formatting with the **Secure deletion – Slow** option enabled takes several hours. You can also use suitable applications on Windows, Linux/UNIX and Mac OS X systems to repartition and safely erase the MicroSD card.

Format SD card:  
**Admin Menu > Storage on External File Server / Flash Device**

The **Secure deletion – Slow** option takes several hours. You can also use suitable applications on Windows, Linux/UNIX and Mac OS X systems to repartition and safely erase the SD card.

Activate recording:  
Admin Menu >  
Storage on External File  
Server / Flash Device

### 3.4.3 Activating MicroSD Card Recording

Follow these steps to activate the recording to a MicroSD card that has already been MxFFS-formatted (**Admin Menu > Storage on External File Server / Flash Device**):

1. Make sure that there is a MicroSD card in the card slot of the MOBOTIX camera.
2. Make sure that the MicroSD card is formatted in MxFFS format.
3. Activate the **SD Flash Card** option.
4. Click on **Set** and then **Close** to store the configuration.
5. Reboot the MOBOTIX camera (**Admin Menu > Reboot Camera**).

Once the camera has rebooted, make sure that the camera displays the **FR REC** symbols in its live image. If this is the case, the camera uses the MicroSD card as recording target. If not, you must activate the recording (see below).

#### Activating The Recording

If the **FR REC** symbols are not visible in the live image after rebooting, you need to activate the recording using one of the following methods:

- **In the web browser:** Automatic activation by clicking on the **Arm & Record** softbutton. Confirm this in the Easy Dialog by clicking on the **Yes** button.
- **In the web browser:** Manual activation via the Quick Control **Recording > Recording on** or in **Setup Menu > Recording**.
- **MxEasy:** It is possible to activate the recording based on the time or date using the Alarm Planner of MxEasy (see *MxEasy User Manual*).

#### Encryption And Authentication

All video data stored on the MicroSD card is encrypted to ensure security at all times. The password for this is defined during the card's formatting procedure and needs to be entered for authentication whenever the recordings are accessed (see next section).

## MicroSD Card Recording

### 3.4.4 Accessing Data on the MicroSD Card

The following options facilitate access to the stored image and video sequences on a MicroSD card:

- **In the web browser:** Play back the recorded event images without audio directly from the MicroSD card using the Playback view of the camera software.
- **In MxEasy:** Play back the recorded video sequences with audio by accessing the MicroSD card in the MOBOTIX camera via the camera.
- **In MxControlCenter:** Play back the recorded video sequences with audio by accessing the MicroSD card in the MOBOTIX camera via the camera or with a direct access to the MicroSD card via a card reader connected to the computer. Access the card by setting the MicroSD card's drive/volume as a **directory** in MxControlCenter.

If the recordings stored on the MicroSD card were encrypted, you need to enter the password used for the encryption before you can access the data. If this is the case, both MxControlCenter and MxEasy will provide a dialog box for this purpose.

#### Caution

When **using the MicroSD card from one MOBOTIX camera in another MOBOTIX camera**, you need to make sure that the time on the original camera is in sync with the new camera. We recommend using automatic time synchronization via a time server (**Admin Menu > Date and Time**).

### 3.4.5 Deactivating Card Recording

Follow these steps to deactivate the memory on a MicroSD card (**Admin Menu > Storage on External File Server / Flash Device**):

1. Activate the **None** option.
2. Click on the **Set** button at the bottom of the dialog box and then on **Close**.
3. Reboot the MOBOTIX camera (**Admin Menu > Reboot Camera**).

Once the camera has rebooted, make sure that the symbol **FR REC** is no longer visible in the bottom right-hand corner of the live image. You can now safely remove the MicroSD card from the camera (see *Section 2.8, «Replacing the MicroSD Card»*).

**Caution**

A **MicroSD card may only be removed from the camera after you have deactivated the recording** to MicroSD card and **rebooted the camera**. **Failing to do so may lead to data loss!**

Removing connected flash storage devices from the camera without properly deactivating them may lead to data loss and/or destroy certain areas of the storage device. This is limited to 4 MB of lost data per incident due to MxFFS formatting.

### 3.4.6 Using a MicroSD Card in a Different MOBOTIX Camera

A MicroSD card containing recorded video data from a MOBOTIX camera can be inserted into any MicroSD card-enabled MOBOTIX camera. Once a MicroSD card recording has been activated (requires a reboot), the “new” MOBOTIX camera automatically synchronizes with the card and resumes recording. No data is lost in this process. Make sure that you deactivate MicroSD card recording before removing the card and then reboot the MOBOTIX camera.

If the MicroSD card’s contents are encrypted, you need to enter the same password in the “new” camera in the **Admin Menu > Storage on External File Server / Flash Device** dialog box. Otherwise, the camera cannot access the MicroSD card.

### 3.4.7 Limitations on Warranty When Using Flash Storage Media

MOBOTIX will not assume any responsibility for flash storage devices (for example, MicroSD cards or connected USB storage devices) delivered with or integrated into MOBOTIX cameras. The same applies to damage to flash storage devices or damage resulting from the use of devices that are not supplied by MOBOTIX.



### 3.5 Configuration in the Browser

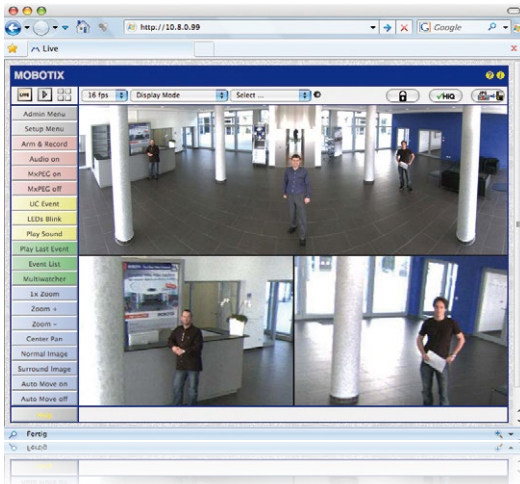

#### 3.5.1 Overview

A MOBOTIX camera can be completely configured using a JavaScript-enabled browser on all common operating systems (such as Windows, Linux, Apple, etc.). The camera provides a HTML-based user interface for this purpose. The camera executes the changes you make to the camera configuration via HTTP commands using programs and scripts of the embedded software. The settings are stored in the camera's flash memory.

This section contains an overview of the basic browser settings of the MOBOTIX camera as well as further configuration options. Detailed information on the software functions is provided in the camera's online help.

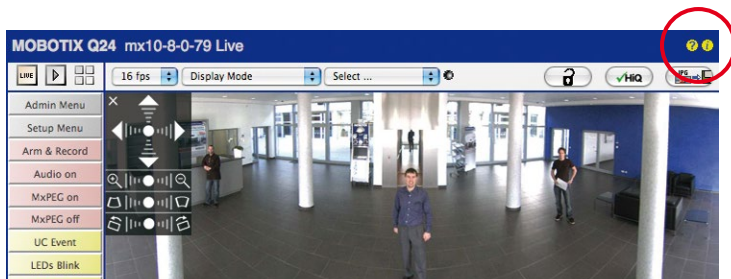

User name: admin  
password: meinsm

Admin Menu

Setup Menu

Make sure to permanently store changed parameters!

Automatic time synchronization using a time server

More: Display advanced features

Less: Hide advanced features

### Basic Settings

- **Administering the camera:** You can modify the camera configuration in the Admin Menu or the Setup Menu.
  - **Admin Menu:** This menu contains the basic configuration dialog boxes of the camera (for example, passwords, interfaces, software updates).
  - **Setup Menu:** This menu contains the dialog boxes for configuring the image, event and recording parameters. Some of these settings can be changed using the corresponding Quick Controls in the live view.
- **Resetting changes:** If you would like to reset some larger changes in one dialog box without resetting the complete configuration, you can use the **Default** button at the bottom of the dialog box to reset only this dialog box's settings to the factory defaults. If you would like to reset all image settings, you can do so using the **Manage Settings > Restore Image Settings** Quick Control in the live image of the camera.
- **Storing changes permanently:** Once you have finished configuring the camera, you should always store the settings in the camera's permanent memory. You can do so in each dialog box (clicking on the **Set** button at the bottom of each dialog box will temporarily implement the change; when you click **Close**, you will be asked to store the complete configuration in the camera's permanent memory) or in the Admin Menu (**Admin Menu > Store current configuration into flash memory**). The **Configuration** section of the Admin Menu provides more functions for storing, copying and managing camera settings. For more information on this topic, refer to the online help for the specific dialog boxes.
- **Time tasks and time synchronization:** Apart from a multitude of possibilities for controlling the camera using time (time tables, holiday and vacation, scheduled tasks, etc.), the camera can also synchronize its internal clock. This allows you to manually synchronize the camera with a computer or automatically using a time server or another MOBOTIX camera. The camera can use either NTP time servers or Time Protocol servers. For more information on this topic, refer to the online help for the specific dialog boxes.
- **The "More" and "Less" buttons:** When opening some of the camera dialog boxes, the camera only shows the most important parameters. These dialog boxes have a **More** button in the bottom right-hand corner. Click it to display additional options. If all options are displayed, click on the **Less** button to hide the additional options.

### 3.5.2 General Browser Settings

- **Run the Quick Installation:** After booting a new MOBOTIX camera, accessing the administration menu for the first time will automatically start the Quick Installation assistant (**Admin Menu** button). The Quick Installation assistant helps you in setting the most important parameters of the camera. For security reasons, you should set your own administrator password and disable public access to the camera.
- **Disable public access:** Guest users are only allowed to access the Guest screen of the camera without entering a password. If this is not required, you should deactivate public access (**Admin Menu > Quick Installation** or **Admin Menu > Users and Passwords**).
- **Add users and assign access rights:** Similar to a computer operating system, you can add users and user groups and assign the desired rights (**Admin Menu > Users and Passwords**, **Admin Menu > Group Access Control Lists (ACL)**). This approach allows individual access rights to be assigned or denied to camera-specific features based on the user groups.
- **Deactivate the automatic reboot:** In its factory state, every MOBOTIX camera will automatically reboot at 3:36 a.m. every day. All images in the camera's storage buffer will be deleted during this reboot. Images stored on external file servers, internal flash storage, or SD cards will NOT be affected by this reboot. Make sure that you deactivate the automatic reboot if this is not desired (**Admin Menu > Time Tasks**).
- **Optimize the image settings:** The factory image settings of MOBOTIX cameras deliver excellent images for most application scenarios and should therefore not be changed. If you do wish to make changes, your changes should be minor and gradual. You should, however, set an image program according to the application scenario of the camera. Image programs provide a quick and simple method for adjusting the camera to the application scenario as they perform several configuration steps at once (**Image Programs Quick Control**).
- **Set the resolution of the live image:** By default, all MOBOTIX cameras are factory-set to an image resolution of 640 x 480 pixels. You can select the desired resolution using the **Resolution Quick Control**.
- **Adjust the exposure:** The automatic exposure control of the MOBOTIX camera uses individually configurable exposure windows to determine the best image exposure. Open the **Exposure Control Quick Control** and select a predefined set of exposure windows. If required, you can also define custom exposure windows (**Setup Menu > Exposure Settings**).
- **Activate event control and recording:** By default, the MOBOTIX camera's event control is disabled. Click on the **Arm & Record** button to activate event control. This will activate motion detection and recording. Cameras with integrated flash memory (MOBOTIX R models and models with an SD card) will automatically use the flash memory to store image and video data (recording target). If desired, you can set additional events and adjust the settings of the recording and storage parameters (**Setup Menu > Event Settings**, **Setup Menu > Recording** and **Admin Menu > Recording to External File Server / Flash Device**).

- **Set up actions/messaging:** Upon detecting an event, the MOBOTIX camera can trigger alarms. These alarms can be adjusted to your needs and you can assign them to a specific event: playing back an alarm sound on the camera speaker, showing the visual alarm in the camera live image, sending an e-mail or network message with the alarm image, placing a phone call, uploading an alarm image to an FTP server, switching a signal output line of the camera (for example, for switching on the lights/opening a door).

For the settings, see **Setup Menu > Action Group Overview**. The actions to be performed are defined and used in these action groups in the form of "action profiles." The different action profiles can also be defined in the following areas: Admin Menu in the Hardware Configuration (profiles for signal output), Transfer Profiles (FTP, e-mail, network messages) and Sound and VoIP Telephony (sound profiles, VoIP profiles). For more information, refer to the online help for the **Action Group Overview** dialog box.

- **Activate shock detector:** The Q25M is also equipped with a shock detector as standard (for all IT and Secure models). If, for example, the camera's housing receives a blow, it automatically registers it and sends a notification via a network message or telephone call. A general advantage is that MOBOTIX cameras are extremely tough because of the absence of mechanical moving parts. This allows them to stay fully operational when they are subject to strong vibrations. Open the **Setup Menu > Event Control > Environment Events > Edit** dialog box if you would like to activate the shock detector (and any other sensors).

### 3.6 Additional Notes

#### 3.6.1 Weatherproofness

The MOBOTIX Q25M-Secure is has been certified according to protection class IP65 (absolutely dustproof and resistant against water jets) and can also be wall-mounted outdoors using the corresponding wall mount. The MOBOTIX Q25M-Basic has been certified according to protection class IP54.

#### 3.6.2 Password for the Admin Menu

Accessing the Administration Menu of the camera (**Admin Menu** softbutton) is only possible after entering a user name and password.

- Factory default user name is **admin**.
- Factory default password is **meinsm**.

The **Quick Installation** assistant automatically appears when the Administration Menu is accessed for the first time. It provides an easy method to adjust the basic camera settings to the current application scenario. For security reasons, we highly recommend changing the default administrator password after the camera has been properly configured.

Enter the user name and password exactly as shown above. Note that all entries are case-sensitive.

#### Caution

Make sure that you store information on **user names and passwords** in a secure place. If you lose the administrator password and cannot access the administration menu, the password can only be reset at the factory. This service is subject to a fee!

#### 3.6.3 Permanently Deactivating the Microphone

Deactivating a camera's microphone may be necessary in order to protect the privacy of persons at a workplace or for other reasons. You can permanently and irreversibly deactivate the microphone in the **Admin Menu > Loudspeaker and Microphone** dialog box.

The microphone can be irreversibly deactivated!

#### 3.6.4 Starting the Camera with the Factory IP Address

If the camera's IP address is not known, you can start the camera with its factory IP address. *Section 3.2.6, «Starting The Camera With The Factory IP Address»* describes this procedure in more detail.

You can reset specific parts of the configuration



If the dotted rectangle in the live image is visible, the camera is armed

Text and logos can be also deactivated or individually configured

### 3.6.5 Resetting the Camera to Factory Settings

All settings of the MOBOTIX camera can be permanently reset to the factory default settings. This makes sense if you have, for example, obtained a camera without any information or you would like to reset all settings after testing the camera. In order to perform this procedure, you need to have administrative access to the camera (admins group). Open **Admin Menu > Reset** to reset the camera to factory defaults.

#### Note

All defined users are deleted and the admin password is reset to the factory default when you reset the camera using **Admin Menu > Reset**. If you want to maintain the existing users, use the method described in *Section 3.2.6, «Starting The Camera With The Factory IP Address»*.

### 3.6.6 Activating Event Control and Motion Detection

In its default configuration, the camera's event control and video motion detection features are not enabled. In order to activate event-controlled recording, open **Setup Menu > General Event Settings** and activate the Arming switch. Another method is to click on the **Arm & Record** softbutton in the browser's user interface. The camera displays the motion detection window in the live image (dotted frame in the center) and the camera automatically stores images as soon as the motion detection window detects movements.

### 3.6.7 Deactivating Text and Logo Options

As camera arming is deactivated in the camera's default configuration (see preceding section), the MOBOTIX camera only displays the text `www.mobotix.com`, the time stamp and the MOBOTIX logo at the top of the image. Once the camera arming has been activated, the text at the bottom of the live image (event, action, messaging and recording symbols) will also appear.

You can deactivate the status bar at the bottom of the live image and the text bar in the top left-hand corner by setting Text Display in the **Setup Menu > Text & Display Settings** dialog box to **Off**. Setting Text Display to **Date and Time** will only display the time stamp in the live image. To hide the logo in the live image, open **Admin Menu > Logo Profiles** and set **Logo Display** to **Deactivated**.

### 3.6.8 Deactivating the Camera Reboot

By factory default, the MOBOTIX camera automatically reboots once a week between 3 a.m. and 4 a.m. The reason for this is that in some rare cases, external influences (for example, radiation at high altitudes) can sometimes lead to camera malfunctions. The automatic reboot will refresh the camera's memory and will ensure proper operation without requiring any interaction on the part of the user. If desired, you can deactivate the automatic reboot of the camera in the **Admin Menu > Time Tasks** dialog box.

## Additional Notes

### 3.6.9 Browser

Current Internet browsers (Internet Explorer, Mozilla Firefox, Safari, Google Chrome, Opera, etc.) with enabled JavaScript can display the camera's live images with their standard settings.

### 3.6.10 Cleaning the Camera and Lens

If the lens becomes dirty during the installation process, clean the lens using a lint-free cotton cloth. Make sure that the lens is still in focus after cleaning and adjust its focus if required.

#### Cleaning The Dome:

- Always mount and unmount the dome using the blue lens wrench (1.3) in order to protect it from being scratched and from getting dirty.
- You should clean the dome at regular intervals. Always use a soft, lint-free cotton cloth for this purpose.
- If the dirt is more persistent, add a mild alcohol-free detergent without abrasive particles.
- Make sure you instruct cleaning personnel on how to clean the camera.



### 3.6.11 Legal Notes

**Legal aspects of video and sound recording:** You must comply with all data protection regulations for video and sound monitoring when using MOBOTIX products. Depending on national laws and the installation location of the Q25M, the recording of video and sound data may be subject to special documentation or it may be prohibited. All users of MOBOTIX products are therefore required to familiarize themselves with all valid regulations and comply with these laws. MOBOTIX AG is not liable for any illegal use of its products.



### 3.6.12 Safety Warnings

#### Installation Instructions:

- This product must not be used in locations exposed to the dangers of explosion.
- Make sure to install this product as shown in *Chapter 2, «Installation»* of this manual.
- When installing this product, make sure that you are only using genuine MOBOTIX parts and MOBOTIX connection cables.
- Make sure that you are installing this product on a solid surface that provides for a sturdy installation of the fixing elements used.



**Electrical installation:** Electrical systems and equipment may only be installed, modified and maintained by a qualified electrician or under the direction and supervision of a qualified electrician in accordance with the applicable electrical guidelines. Make sure to properly set up all electrical connections.





**Electrical surges:** MOBOTIX cameras are protected against the effects of small electrical surges by numerous measures. These measures, however, cannot prevent the camera from being damaged when stronger electrical surges occur. Special care should be taken when installing the camera outside of buildings to ensure proper protection against **lightning**, since this also protects the building and the whole network infrastructure.



**Max. power consumption of attached extension modules:** The power consumption of all attached *MxBus modules* must **not exceed 2.5 W**. When attaching modules to the MxBus connector **and** the USB connector, the **power consumption of all attached modules must not exceed 3 W, if the camera is powered by PoE class 3**. If **PoE class 2** is used, **the power consumption of all attached modules must not exceed 1 W!**



**Never touch the lens:** Due to the high performance of the Q25M, the area of the image sensor **can get quite hot**, especially when the ambient temperature is also high. This does not affect the proper functioning of the camera in any way. For this reason, the product must not be installed within the reach of persons without the dome.





**Power off before opening the camera:** Make sure the power supply is disconnected before opening the camera (i.e., for installing or replacing sensor modules and SD cards).



**Network security:** MOBOTIX products include all of the necessary configuration options for operation in Ethernet networks in compliance with data protection laws. The operator is responsible for the data protection concept across the entire system. The basic settings required to prevent misuse can be configured in the software and are password-protected. This prevents unauthorized parties from accessing these settings.

### 3.6.13 Online Help in the Browser

For more information, see the News and Functional Overview pages in the online help of the camera's browser interface. Click on the  icon to open the camera's online help. Furthermore, detailed information on the camera and its current configuration is displayed in the **Camera Status** dialog box. Click on the  icon to open the relevant page.

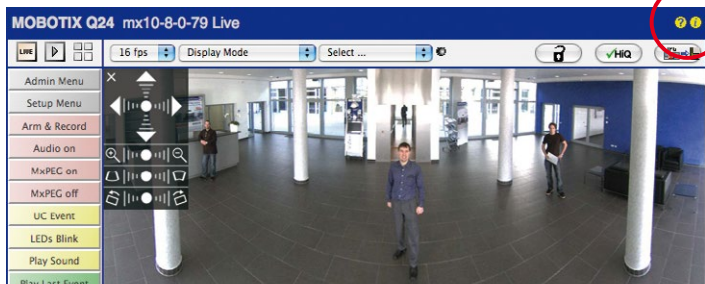



### 3.6.14 Declaration of Conformity

The products of MOBOTIX AG are certified according to the applicable directives of the E.U. and other countries. You can find the declarations of conformity of the products of MOBOTIX AG under [www.mobotix.com](http://www.mobotix.com), **Support > MX Media Library > Certificates > Declarations of Conformity**.

### 3.6.15 Disposal

Electrical and electronic products contain many reusable materials. For this reason, we would ask that you dispose of MOBOTIX products at the end of their service life in accordance with all legal requirements and regulations (or deposit these products at a municipal collection center). MOBOTIX products may not be disposed of with household waste! If the product contains a battery, please dispose of the battery separately (the corresponding product manuals contain specific directions if the product contains a battery).



### 3.6.16 Disclaimer

MOBOTIX AG does not assume any liability for damage that is the result of improper use of its products or failure to comply with the operating manuals or the applicable rules and regulations. Our **General Terms and Conditions** apply. You can download the current version at [www.mobotix.com](http://www.mobotix.com) (using the COS link at the bottom of each page).







To demonstrate our confidence in the quality of our products, MOBOTIX cameras have been used to capture all images that appear in this manual.

**Manufacturer**

MOBOTIX AG  
Kaiserstrasse  
67722 Langmeil  
Germany

Phone: +49 6302 9816-103

Fax: +49 6302 9816-190

[www.mobotix.com](http://www.mobotix.com)

[sales@mobotix.com](mailto:sales@mobotix.com)

Registration Office: Kaiserslautern Local Court

Registration Number: HRB 3724

Tax Office: Worms-Kirchheimbolanden, Germany

Tax Code: 44/676/0700/4

VAT ID: DE202203501

You can find the latest version of this and other documents (e.g., declarations of conformity) at [www.mobotix.com](http://www.mobotix.com) in the **Support** section.



Technical specifications subject to change without notice!



reddot design award

## Allround Easy. Allround Secure.

Elegant, ultra-compact and weatherproof 5MP dome camera. Its 360° allround view allows monitoring and recording an entire room, while the panorama image and image analysis tools of the Q25M Hemispheric provide an unparalleled range of application scenarios.



5 MP  
Sensor

MxLEO



360°

vPTZ



MxBUS

USB

+50°  
-30°

IP65



Innovations – Made in Germany

The German company MOBOTIX AG is known as the leading pioneer in network camera technology and its decentralized concept has made high-resolution video systems cost efficient.

MOBOTIX AG • D-67722 Langmeil • Tel: +49-6302-9816-103 • Fax: +49-6302-9816-190 • sales@mobotix.com